

**posfix<sup>®</sup>**

**RETAIL DISPLAY  
SOLUTIONS**

**'23/24**

# OUR MERCHANDISING AND CUSTOMER COMMUNICATION SOLUTIONS



1

**SHELF  
MANAGEMENT**  
2-27



2

**PLASTIC FRAMES AND  
FIXING ACCESSORIES**  
28-61

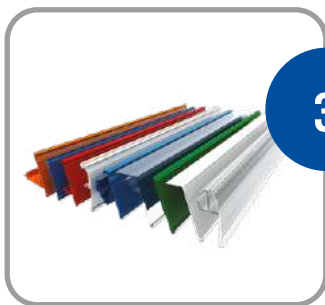

3

**DATASTRIPS AND ESL  
HOLDERS**  
62-73



4

**PRICE LABEL HOLDERS  
AND PRICE CASSETTES**  
74-103



5

**INFORMATION  
HOLDERS**  
104-117



6

**DISPLAY  
ACCESSORIES**  
118-135



7

**SHELFALKERS  
AND SIGN HOLDERS**  
136-143



8

**SUSPENSION  
SYSTEMS**  
144-155



9

**DISPLAYS AND  
CROSS-MERCHANDISING**  
156-163



**WIDE RANGE OF RETAIL MERCHANDISING AND DISPLAY SOLUTIONS**

We offer a wide range of standard products to make modern stores look better and be more efficient.



**WE KEEP LARGE STOCK OF PRODUCTS TO ENSURE FAST DELIVERY**

We know that you like to get your orders as soon as possible - for that we keep on stock a wide range of our products.



**WE MANUFACTURE OUR PRODUCTS TO ENSURE HIGH QUALITY AT LOW PRICE**

No intermediaries - you get our products right from our production.



**TRUSTED BY LEADING RETAILERS AND BRAND MANUFACTURERS**

Our products are used by leading retailers, display companies and brand manufacturers throughout the world.



# 1 SHELF MANAGEMENT

- 4 Best solutions
- 8 Lock dividers and fixing profiles
- 10 T-, L-base dividers
- 12 Chocolate trays
- 13 Plastic base supports
- 14 Spring pushers
- 20 Divider and pusher fixing profiles
- 22 FORTA ROLL shelf system
- 26 Freezeline system for freezers

# GOOD SHELF MANAGEMENT LEADS TO:



Sales growth up to 30% thanks to better product presentation



Lower costs on merchandizing



Lower product waste sign off



Lower out of stocks due to better product visibility

## BEST SOLUTIONS



Stationary



Grocery



Household products



DIV-L **270169-xx** [p. 12]



Pharmacy products



Health & Beauty products

DIV60-BT60 **270035** [p. 9]  
T-RAIL10 **270004** [p. 20]



Sliced meat, fish, cheese

DIV120-BT80 **270203** [p. 9]  
BACK-XL-TM **270077** [p. 13]  
T-RAIL30-TM **270067** [p. 21]



Chocolates



Tobacco products

FORTA GROSSA-1 **270808** [p. 18]  
DIV60-BT60 **270035-xx** [p. 9]  
T-RAIL30 **270066-xx** [p. 21]



Tobacco products



Spices



Hair colorants

FORTA NORMA-0 **270661** [p. 16]  
DIV60-BT30 **270071-00-xx** [p. 8]  
T-RAIL10 **270004** [p. 20]



DIV30-B 270750 [p. 8]  
T-RAIL10 270004-xx [p. 20]



DIVT-T-150 270226 [p. 11]



FORTA GROSSA-4 270646 [p. 15]  
DIV120-B 270014-xx [p. 9]



CHOCO-TRAY 200900 [p. 12]



DIV120-BT80 270203 [p. 9]  
BACK 500731 [p. 13]  
BACKLINE 500730 [p. 13]  
T-RAIL30 TM 270067 [p. 21]



DIVT-150 270054 [p. 10]

### LOCK DIVIDERS AND FIXING PROFILES

The shelf dividers of this type are fixed on the fixing T-profiles. They help to keep good order on shelf and clearly separate different products.



**DIV30-B** Breakable 30 mm divider

Breakable 30 mm divider.

Height: 30mm  
 Length: 185-285mm  
 (2 break points, making lengths: 185,235,285 mm),  
 185-385mm  
 (4 break points, making lengths: 185, 235, 285, 335, 385 mm)

Color: **Tr**  
 Packaging: 10 pcs.

LENGTH / MM	CODE
185-285	270751
185-385	270750



**DIV30-BT35** Breakable 30 mm T-divider with 35mm high T-front

Breakable 30 mm T-divider with 35 mm high T-front.

Height: 30 mm.  
 Length: 185-285mm  
 (2 break points, making lengths: 185, 235, 285 mm),  
 185-385mm  
 (4 break points, making lengths: 185, 235, 285, 335, 385 mm)

Color: **Tr**  
 Packaging: 10 pcs.

LENGTH / MM	CODE
185-385	270475
285-485, 385-585	270014-xx

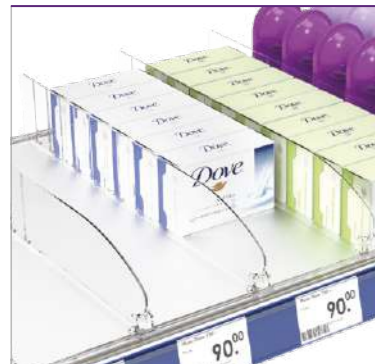

**DIV60-B** Breakable 60mm divider

Breakable 60 mm divider.

Height: 60 mm.  
 Length: 185-385 mm. (break points every 25 mm),  
 285-485 mm. (break points every 25 mm).

Color: **Tr**  
 Packaging: 10 pcs.

LENGTH / MM	CODE
185-385	270476
285-485, 385-585	270203-xx



**DIV60-BT30** Breakable 60mm T-divider with 30mm high T-front

Breakable 60 mm T-divider with 30 mm high T-front.

Height: 60 mm.  
 Length: 185-385mm. (break points every 25 mm),  
 285-485mm. (break points every 25 mm).

Color: **Tr**  
 Packaging: 10 pcs.

LENGTH / MM	CODE
185-385	270477
285-485, 385-585	270202-xx

**DIV60-BT60** Breakable 60mm divider with 60 mm high T-front

Height: 60 mm.  
 Length: 185-385 mm. (break points every 25 mm),  
 285-485 mm. (break points every 25 mm).

Color: **Tr**  
 Packaging: 10 pcs.

LENGTH / MM	CODE
185-385	270475
285-485, 385-585	270014-xx

**DIV120-B** Breakable 120mm divider

Breakable 120 mm divider.

Height: 120 mm.  
 Length: 185-385 mm (break points every 25 mm),  
 285-485mm (break points every 25 mm),  
 385-585mm (break points every 25 mm)

Color: **Tr**  
 Packaging: 20 pcs.

LENGTH / MM	CODE
185-385	270475
285-485, 385-585	270014-xx



**DIV120-BT80** Breakable 120mm T-divider with 80mm high T-front

Height: 120 mm.  
 Length: 185-385 mm (break points every 25 mm),  
 285-485mm (break points every 25 mm),  
 385-585mm (break points every 25 mm)

Color: **Tr**  
 Packaging: 20 pcs.

LENGTH / MM	CODE
185-385	270475
285-485, 385-585	270014-xx

**DIV120-BT80** Breakable 120mm T-divider with 80mm high T-front

Breakable 120 mm T-divider with 80 mm high T-front.

Height: 120 mm.  
 Length: 185-385 mm. (break points every 25 mm),  
 285-485 mm. (break points every 25 mm),  
 385-585 mm. (break points every 25 mm)

Color: **Tr**  
 Packaging: 20 pcs.

LENGTH / MM	CODE
185-385	270476
285-485, 385-585	270203-xx



**DIV120-BT120** Breakable 120mm T-divider with 120mm high T-front

Height: 120 mm.  
 Lengths: 185-385 mm  
 285-485 mm  
 385-585 mm

Color: **Tr**  
 Packaging: 20 pcs.

LENGTH / MM	CODE
185-385	270477
285-485, 385-585	270202-xx

**DIV120-BT120** Breakable 120mm T-divider with 120mm high T-front

Breakable 120mm high divider with 120mm high T-front part. Recommended to use in combination with pushers and back supports.

Height: 120 mm.  
 Lengths: 185-385 mm  
 285-485 mm  
 385-585 mm

Color: **Tr**  
 Packaging: 20 pcs.

LENGTH / MM	CODE
185-385	270477
285-485, 385-585	270202-xx



**DIV120-BTW120** Breakable 120mm T-divider with a detachable wide T-front

Height: 120 mm.  
 Lengths: 285-485 mm

Color: **Tr**  
 Packaging: 20 pcs.

LENGTH / MM	CODE
285 - 485	270230

**DIV120-BTW120** Breakable 120mm T-divider with a detachable wide T-front

Breakable 120 mm high divider with 120 mm high detachable 100 mm wide T-front part. Recommended to use in combination with pushers and back supports.

Height: 120 mm.  
 Lengths: 285-485 mm

Color: **Tr**  
 Packaging: 20 pcs.

LENGTH / MM	CODE
285 - 485	270230





**DIV200** Fixed length 200mm divider

Fixed length 200mm lock divider.  
Length: 385 mm, 485 mm, 585 mm

Color:

Packaging: 10 pcs.

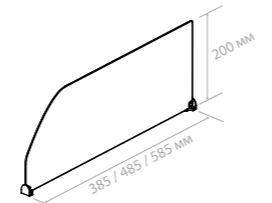

CODE  
270017-xx

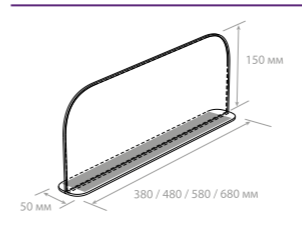

CODE  
270085-xx

**DIVT-150-TM** Free standing 150mm high divider with magnetic base

This injected 150 mm high divider is universal to use to organize food and non-food products on shelves. Thanks to its magnetic base it is very stable on metal shelves.

Available in several lengths.

Lengths available – 380 mm, 480 mm, 580 mm, 680 mm.

Color:

Packaging: 20 pcs.



### T-, L-BASE DIVIDERS

These dividers do not require any fixing profiles and are very simple to use – you just put them on the shelf and they start working.



**DIVT-80** Freestanding divider, 80mm high

Easy to install and use, this universal divider helps to separate food and non-food products. Three different lengths for use on different shelf types.

Color:

Packaging: 10 pcs.

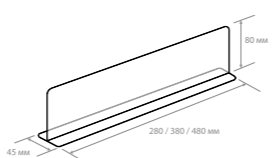

LENGTH / MM	CODE
280	270391
380	270392
480	270393

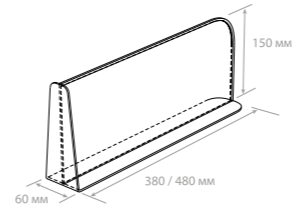

LENGTH / MM	CODE
380	270226
480	270227

**DIVT-T-150** Free standing 150mm high divider with T-front

This injected 150 mm high divider has a T-shaped front part to keep the products from falling down. The other part of the divider has no T-front, thus making the use of this divider more versatile.

Lengths available – 380 and 480 mm.

Color:

Packaging: 20 pcs.



**DIVT-80-TM** Freestanding divider with magnetic base, 80mm high

Freestanding divider with magnetic base, 80 mm high. The magnetic base makes the divider especially stable on the metal shelf, while having the full flexibility of the free-standing shelf divider.

3 lengths available – 280, 380, 480 mm

Color:

Packaging: 10 pcs.

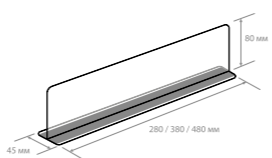

LENGTH / MM	CODE
280	270430
380	270431
480	270432

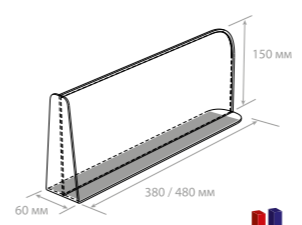

LENGTH / MM	CODE
380	270228
480	270229

**DIVT-150-TM** Free standing 150mm high divider with magnetic base and T-front

This injected 150mm high divider has a T-shaped front part to keep the products from falling down. The magnetic base helps to better fix the divider on metal shelves.

Lengths available – 380 and 480 mm.

Color:

Packaging: 20 pcs.



**DIVT-150** Injected freestanding T-divider

Injected freestanding T-divider.

Height: 150 mm  
lengths available: 380, 480, 580, 680mm.  
There is an option with magnetic tape for a more secure fixing on shelf.

Color:

Packaging: 20 pcs.

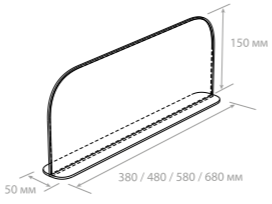

CODE  
270054-xx

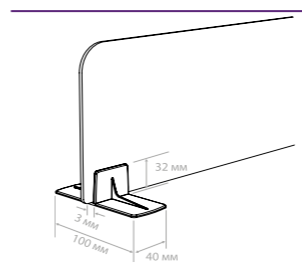

SCOTCH TAPE	CODE
-	270074
	270167

**DIV-FOOT** T-clip for customised dividers

This T-clip is a good tool to make a customised divider you need. With 2 clips you can make dividers from acrylic or PET plastic sheet with 3 mm thickness.

Color:

Packaging: 10 pcs.

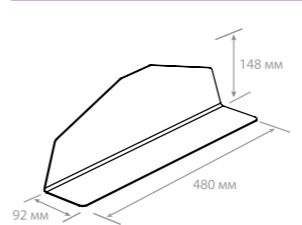
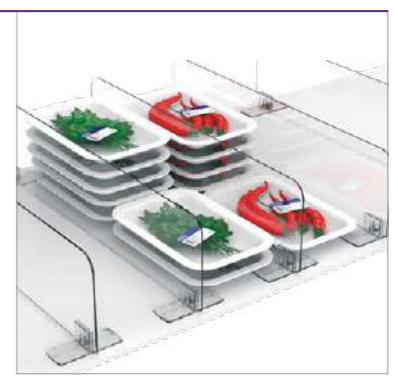

CODE
270908
270907

**DIV-L-SLIM** Injected L-shape divider

This slim L-shaped divider is a good tool to keep good order on shelf, the 480 mm length fits the 500 mm deep shelves that are very common in modern supermarkets.

Color:

Packaging: 20 pcs.







DIV-L

Injected freestanding L-divider

You can use this divider for different instore applications. It is a very versatile tool to keep order on shelf and perfect product presentation.

Color:

Packaging: 10 pcs., 20 pcs.

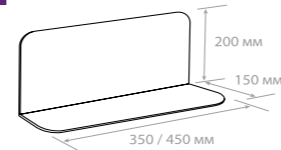

CODE

270169-xx



DIV-LS

Injected freestanding L-divider

Simple to use injected divider to organize bulky products on shelf. 350 and 450 mm length options fit most types of the shelf. Depending on the position you may get it 150 or 200 mm high.

Color:

Packaging: 20 pcs.

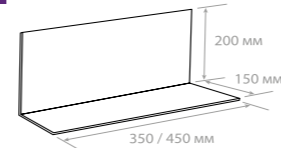

CODE

270191-xx

### INJECTED CHOCOLATE TRAYS

A simple to use solution for bar chocolate on-shelf presentation. The fixed width of the trays fits most of the chocolate bars available on the market, the back support helps to make perfect presentation of the product to the shoppers.



CHOCO-TRAY

Injected tray for chocolate bars

Injected tray for chocolate bars with back support.

Width: 82 mm,  
Length: 395 mm,  
3 break points making lengths 385 and 435 mm.

Color:

Packaging: 4 pcs.

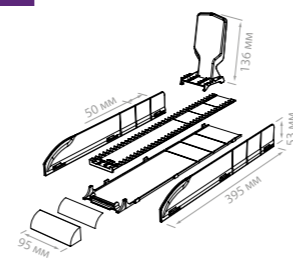

CODE

200900

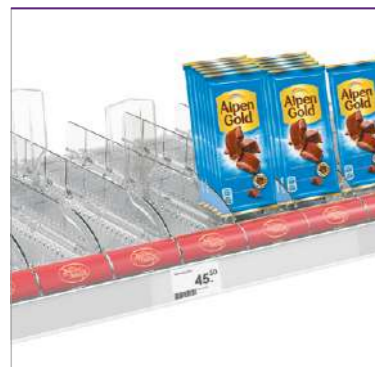

CHOCO-TRAY-SET11

Chocolate trays set to fit standard shelves

The chocolate trays are connected together to fit a 1000 mm shelf (11 facings) or 1250 mm shelf (13 facings)

Color:

Packaging: 1 pcs.

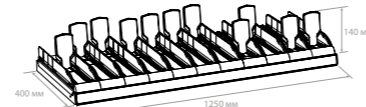

CODE

200901

### PLASTIC BACK SUPPORTS

Used in combination with shelf dividers, back supports help to create attractive product presentation of flat products (e.g. sliced cheese, meat or fish) on shelf.

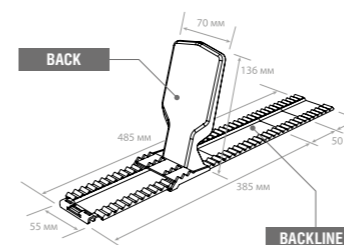

BACK+BACKLINE

Track for back support with small plastic back support

A set of back support and back support track. Mounted on T-rail. The back support can be moved on track manually or using plastic pullstrip.

Width: 55 mm  
Length: 485mm with several breaking lines to make it 385 and 435mm long.

Color:

Packaging: 10 pcs.

CODE	PRODUCT
500731	BACK
500730	BACKLINE

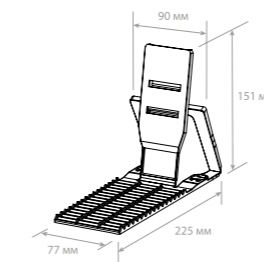

FLEX-BACK

Foldable 2-angle back support

This free-standing back support is a simple but very efficient tool to present flat packed products like chocolates, meat and cheese slices, packed products. You can st 2 angle positions, while when supplied it comes flat packed, thus being very efficient in delivery.

Color:

Packaging: 10 pcs.

CODE

500895

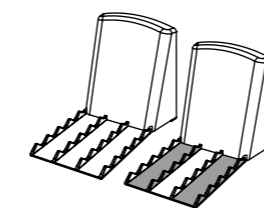

BACK-XL / -TM

Large plastic back support

This large plastic back support has 2 variants - with or without magnetic base. The option with magnetic base is recommended for use on metal shelves for better fixing.

Color:

Packaging: 10 pcs.

CODE	MOUNTING
254206	-
270077	

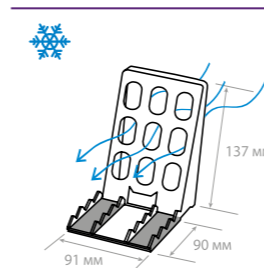

BACK-FR-TM

Large plastic back support with airflow function

This freestanding plastic back support has magnetic base for easy but reliable fixing on metal shelves. The holes in the back part allow the cool air flow through to the product.

Color:

Packaging: 10 pcs.

CODE

270201



### SPRING PUSHERS

Spring pushers is an efficient tool to keep perfect product presentation on shelf. They are widely used with different product groups – both in food and non-food retail stores.



Tobacco products



Chocolate & Sweets



Fish, meat and cheese slices



Spices



Hair colorants



Underwear



### SLICED CHEESE, FISH, MEAT

It is often a challenge to display this type of products on shelf – they are thin and flat and it is difficult to maintain front facing. The right combination of dividers and pushers solves this problem.

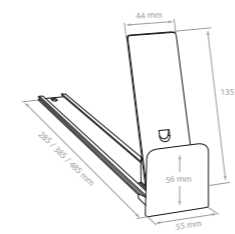

**FORTA GROSSA-2** Pusher with high inclined back support and straight front

This pusher has an inclined back support (44x135 mm) with the straight front (55x56 mm). It can be supplied with different force pusher springs (7-11, 10-14, 14-18N).

The pusher is recommended to use with 120 mm high dividers.

**Color:** Gr  
**Packaging:** 20 pcs.

SPRING FORCE	LENGTH / MM	CODE
7-11	285 / 385 / 485	270814 / 270815 / 270816
10-14	285 / 385 / 485	270817 / 270818 / 270819
14-18	285 / 385 / 485	270820 / 270821 / 270822

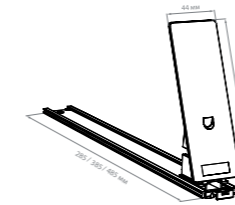

**FORTA GROSSA-0** Pusher with high inclined back support

This pusher has an inclined back support (44x135 mm) with no front. It can be supplied with different force pusher springs (7-11, 10-14, 14-18N).

The pusher is recommended to use with 120 mm high dividers.

**Color:** Gr  
**Packaging:** 20 pcs.

SPRING FORCE	LENGTH / MM	CODE
7-11	285 / 385 / 485	270658 / 270659 / 270660
10-14	285 / 385 / 485	270652 / 270653 / 270654
14-18	286 / 385 / 485	270655 / 270656 / 270657

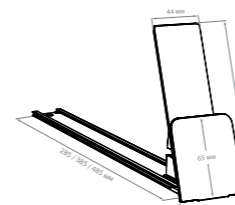

**FORTA GROSSA-4** Pusher with high inclined back support and inclined front

This pusher has an inclined back support (44x135 mm) with inclined front (60x65 mm). It can be supplied with different force pusher springs (7-11, 10-14N).

The pusher is recommended to use with 120 mm high dividers.

**Color:** Gr  
**Packaging:** 20 pcs.

SPRING FORCE	LENGTH / MM	CODE
7-11	285 / 385 / 485	270646 / 270647 / 270648
10-14	285 / 385 / 485	270643 / 270644 / 270645

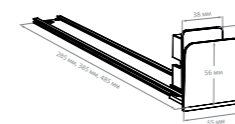

**FORTA NORMA-2** Pusher with medium back support and straight front

This pusher has a smaller back support (38x50 mm) and a straight front (55x56 mm). It is recommended to use with 60 and 120 mm dividers, can be supplied with different force springs – 4-8, 7-11, 10-14N.

**Color:** Gr  
**Packaging:** 20 pcs.

SPRING FORCE	LENGTH / MM	CODE
4-8	285 / 385 / 485	270839 / 270840 / 270841
7-11	285 / 385 / 485	270717 / 270718 / 270719
10-14	285 / 385 / 485	270667 / 270668 / 270669



## TOBACCO PRODUCTS

It has become very common to use spring pushers for merchandising tobacco products. We have a wide range of pusher solutions developed for this product category.



### FORTA NORMA-0 Pusher without front

This classic pusher has a standard back support (38x50 mm) without any front. It can be supplied with springs of different force, but most often it is used with 3N or 4-8N springs.

We recommend to use it in combination with 60 mm high dividers.

**Color:** Gr  
**Packaging:** 20 pcs.

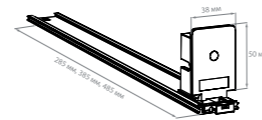

SPRING FORCE	LENGTH / MM	CODE
3	285 / 385 / 485	270661 / 270662 / 270663
4-8	285 / 385 / 485	270739 / 270740 / 270741
7-11	285 / 385 / 485	270714 / 270715 / 270716
10-14	285 / 385 / 485	270711 / 270712 / 270713



### FORTA NORMA-1 Pusher with a small front

This classic pusher has a standard back support (38x50 mm) and a small front. It can be supplied with springs of different force, but most often it is used with 3N or 4-8N springs.

We recommend to use it in combination with 60 mm high dividers.

**Color:** Gr  
**Packaging:** 20 pcs.

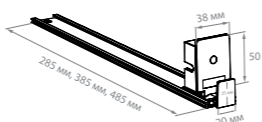

SPRING FORCE	LENGTH / MM	CODE
3	285 / 385 / 485	270664 / 270665 / 270666
4-8	285 / 385 / 485	270824 / 270825 / 270826
7-11	285 / 385 / 485	270842 / 270843 / 270844
10-14	285 / 385 / 485	270845 / 270846 / 270847



### FORTA SLIMA-0 Slim high pusher with no front

This pusher is used to display narrow cigarette packs. The slim back support (15x68 mm) is good to push nearly any slim packs and products available on the market.

Recommended to use with 60 or 120 mm dividers. Supplied with 3 or 4-8N springs.

**Color:** Gr  
**Packaging:** 20 pcs.

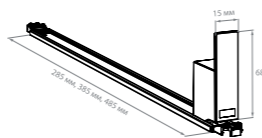

SPRING FORCE	LENGTH / MM	CODE
3	285 / 385 / 485	270685 / 270686 / 270687
4-8	285 / 385 / 485	270764 / 270765 / 270766



### FORTA SLIMA-1 Slim high pusher with small front

This pusher is used to display narrow cigarette packs. The slim back support (15x68 mm) is good to push nearly any slim packs and products available on the market. The front helps to stop product near the shelf edge.

Recommended to use with 60 or 120 mm dividers. Supplied with 3 or 4-8N springs.

**Color:** Gr  
**Packaging:** 20 pcs.

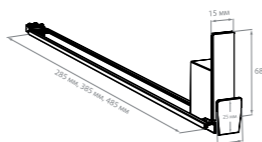

SPRING FORCE	LENGTH / MM	CODE
3	285 / 385 / 485	270688 / 270689 / 270690

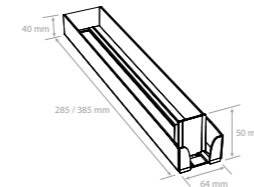

### SIG-TRAY Injected tray for cigarette packs

Injected tray for cigarette packs with integrated pusher.

Width: 59 mm.  
Lengths: 285, 385 mm. 3N spring used by default, other pusher strength available by request.

**Color:** Tr  
**Packaging:** 20 pcs.

CODE
270079-03-0285
270079-03-0385

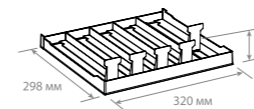

### SIG-TRAY-SET 5 pack cigarette tray

This one-piece set is a part of the SIG-BOX or can be used separately to display standard king size cigarette packs on shelves or custom made cigarette displays.

The tray size is fixed (320x298 mm).

**Color:** Tr  
**Packaging:** 20 pcs.

CODE
270941

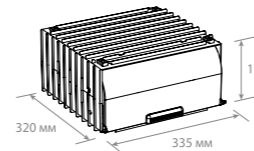

### SIG-BOX Cigarette box with 5-pack pull-out tray and lid

This box can be used individually or as a part of custom made cigarette displays. The 5pack pull-out tray and lid help to create the display you need.

**Color:** Sc Gr

CODE
270957



SIG-BOX units can be connected with each other vertically and horizontally to create a multi unit display wall. Lid opening and closing can be synchronized if necessary.

## CHOCOLATES

Having products near shelf front is crucial for this category, since impulse purchases is the key sales driving force for them. Pushers help to manage this task!



**FORTA GROSSA-1** Pusher with high inclined back support and small front

This pusher has a tall inclined back support (44x135 mm) and small front (20x25 mm). It is recommended to use in combination with DIV60 or DIV120 dividers.

Recommended spring force: 7-11, 10-14N

**Color:** Gr  
**Packaging:** 20 pcs.

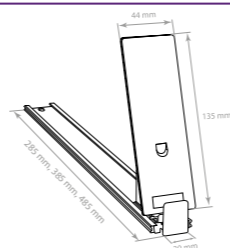

SPRING FORCE	LENGTH / MM	CODE
7-11	285 / 385 / 485	270808 / 270809 / 270810
10-14	285 / 385 / 485	270811 / 270812 / 270813



**FORTA QUADRA-0** Pusher with big inclined back support

This pusher is perfect to merchandize lower chocolate bars. Its low and wide back support ( 75x74 mm) fits these products best.

Recommended to use with DIV60 dividers.  
Recommended spring force: 7-11, 10-14, 14-18N

**Color:** Gr  
**Packaging:** 20 pcs.

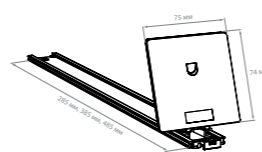

SPRING FORCE	LENGTH / MM	CODE
7-11	285 / 385 / 485	270767 / 270749 / 270768
10-14	285 / 385 / 485	270799 / 270800 / 270801
14-18	285 / 385 / 485	270682 / 270683 / 270684



**FORTA QUADRA-1** Pusher with big inclined back support and small front

This pusher is perfect to merchandize lower chocolate bars and wide sweet packs. Its low and wide back support (75x74 mm) fits these products best, the small front prevents the products from falling.

Recommended to use with DIV60 or DIV120 dividers.  
Recommended spring force: 7-11, 10-14N

**Color:** Gr  
**Packaging:** 20 pcs.

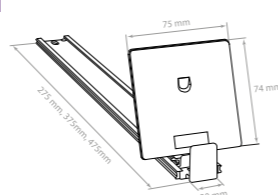

SPRING FORCE	LENGTH / MM	CODE
10-14	285 / 385 / 485	270802 / 270803 / 270804



**FORTA GROSSA-4** Pusher with high inclined back support and big inclined front

This pusher has a tall inclined back support (44x135 mm) and big inclined front (60x65 mm). It is recommended to use in combination with DIV120 dividers.

Recommended spring force: 7-11, 10-14N

**Color:** Gr  
**Packaging:** 20 pcs.

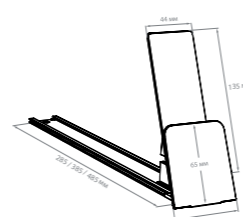

SPRING FORCE	LENGTH / MM	CODE
7-11	285 / 385 / 485	270646 / 270647 / 270648
10-14	285 / 385 / 485	270643 / 270644 / 270645

## HEALTH & BEAUTY

Product presentation plays crucial role in Health&Beauty products sales. It is very important to keep product front-faced and nice looking on shelf. You can achieve it when using the spring pushers.

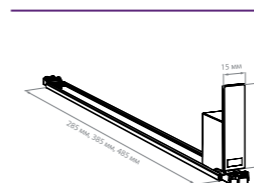

**FORTA SLIMA-0** Slim pusher with high back support

This slim pusher is a great tool to front-face narrow products like mascara, nail varnish etc.

Recommended to use with DIV60 or DIV120 dividers.  
Recommended pusher force: 3, 4-8N

**Color:** Gr  
**Packaging:** 20 pcs.

SPRING FORCE	LENGTH / MM	CODE
3	285 / 385 / 485	270685 / 270686 / 270687
4-8	285 / 385 / 485	270764 / 270765 / 270766

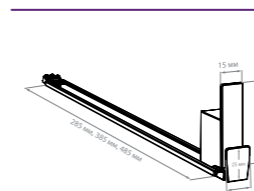

**FORTA SLIMA-1** Slim pusher with high back support and small front

This slim pusher is a great tool to front-face narrow products like mascara, nail varnish etc. The small front keeps the products from falling.

Recommended to use with DIV60 or DIV120 dividers.  
Recommended pusher force: 3, 4-8N.

**Color:** Gr  
**Packaging:** 20 pcs.

SPRING FORCE	LENGTH / MM	CODE
3	285 / 385 / 485	270688 / 270689 / 270690

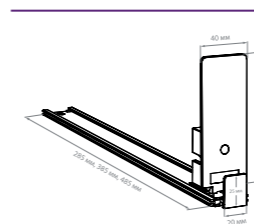

**FORTA MAGNA-1** Pusher with big straight back support and small front

This straight back support (40x100 mm) with small front (20x25 mm) is a good tool to front-face shampoos, shower gels and other similar products.

Recommended to use with DIV60 dividers.  
Recommended spring force: 4-8, 7-11, 10-14N.

**Color:** Gr  
**Packaging:** 20 pcs.

SPRING FORCE	LENGTH / MM	CODE
4-8	285 / 385 / 485	270833 / 270834 / 270835
7-11	285 / 385 / 485	270848 / 270849 / 270850
10-14	285 / 385 / 485	270830 / 270831 / 270832

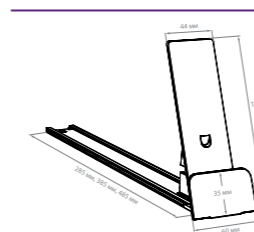

**FORTA GROSSA-3** Pusher with big inclined back support and medium inclined front

This pusher has a tall inclined back support (44x135 mm) and low inclined front (60x35 mm). It is recommended to use in combination with DIV120 dividers.

Recommended spring force: 10-14N.

**Color:** Gr  
**Packaging:** 20 pcs.

SPRING FORCE	LENGTH / MM	CODE
10-14	285 / 385 / 485	270649 / 270650 / 270651



### DIVIDER AND PUSHER FIXING PROFILES

We offer a variety of fixing profiles to mount lock dividers, pushers and back supports on different types of shelves.

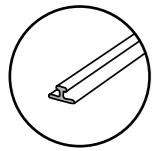

Narrow profile with adhesive tape is widely used for fixing low dividers – 30 and 60 mm high.

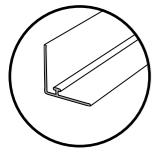

The L-profiles are good to use when you need not just fix the pushers and dividers, but also to avoid the products from falling. It is especially important when using spring pushers.

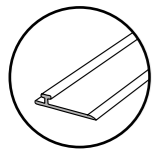

A wider fixing profile is needed to fix higher (120 and 200 mm) dividers.

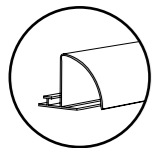

The rounded PRO30 profile has an integrated T-profile. So, you can combine products segmentation with merchandising.



#### T-RAIL10 T-profile

T-profile with adhesive tape (9 mm) for fixing the dividers on shelf.

Width: 10 mm.  
Length: 1000 mm, 1250 mm, 1330 mm.

Color:   
Packaging: 10 pcs.

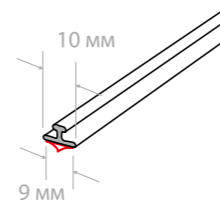
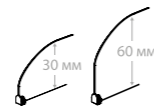

CODE
270004-xx



#### T-RAIL-TEGO T-profile with insert for Tegometal type shelves

This profile is used when mounting dividers on Tegometal type shelves. The profile is inserted into the shelf slots in the front and back parts of the shelf.

Color:   
Packaging: 10 pcs.

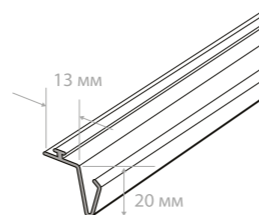
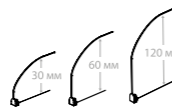

CODE
270020-xx

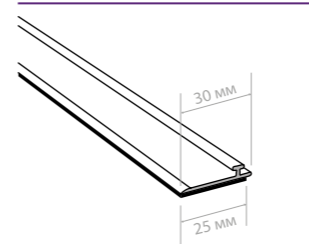

#### T-RAIL30-TF / TM T-profile

T-profile with adhesive foam or magnetic tape (25 mm) for fixing the dividers on shelf.

Length: 1000 mm, 1250 mm, 1330 mm.

Color:   
Packaging: 10 pcs.

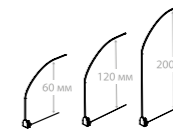

CODE	MOUNTING
270066-xx	SELF-ADHESIVE
270067-xx	

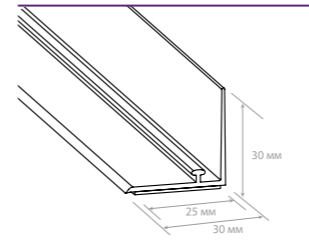

#### L-RAIL30-TF / TM L-Front riser

L-Front riser, with 30 mm high plastic front and integrated T-profile.

Length: 1000 mm, 1250 mm, 1330 mm, 25 mm foam (magnetic) tape strip

Color:   
Packaging: 10 pcs., 40 pcs.

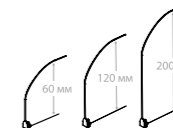

CODE	MOUNTING
270031-xx	SELF-ADHESIVE
270082-xx	

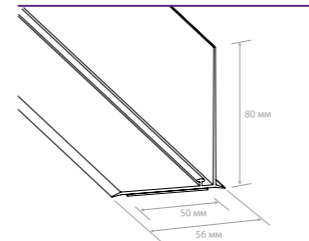

#### L-RAIL80-TF / TM L-Front riser

L-Front riser, with 80 mm high plastic front and integrated T-profile.

Length: 1000 mm, 1250 mm, 1330 mm,  
Height: 80 mm,  
2\*12 mm foam (2\*25mm magnetic) tape strips

Color:   
Packaging: 10 pcs.

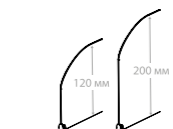

CODE	MOUNTING
270009-xx	SELF-ADHESIVE
270062-xx	

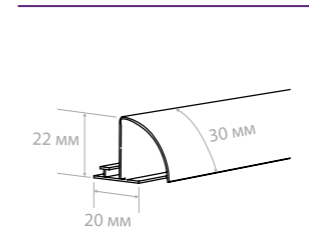

#### PRO30 The rounded segmentation profile

Used as a segmentation profile, it also can be used as a carrier rail for dividers, pushers and BACK supports. The height of paper insert is 30 mm.

The profile is fixed to shelf with adhesive tape.  
Standard lengths: 1000, 1250 mm

Color:   
Packaging: 10 pcs., 50 pcs.

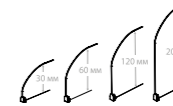

CODE
270034-xx-xx



### MAGNETIC BASE PROFILES

We recommend to order profiles with magnetic base for installation to the coolers. These shelves require regular cleaning and the magnetically attached profiles can be easily removed and put back.



**FORTA ROLL**

FORTA ROLL system is a robust tool for efficient gravity feeding of products on shelf. It makes product replenishment easy, ensures great product visibility and helps to identify out-of-stocks.

**BEFORE**

**AFTER**

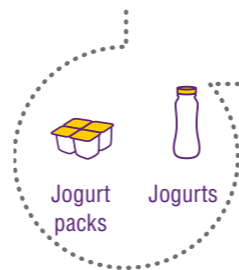



**FR-TRACK**      **FORTA ROLLER Track**

Single roller track is a unit of a roller shelf. You can combine them to get the shelf of necessary width. Separate tracks can also be used in with spare space between them for big boxes merchandizing.

**Color:** Gr  
**Packaging:** 10 pcs.

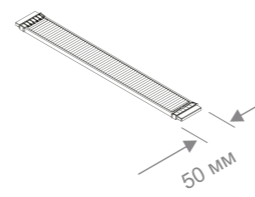

SHELF DEPTH / MM	CODE
400	280104
500	280135
600	280136



**FR-SHEET**      **FORTA ROLLER Sheet**

Ready assembled sheet 500 (w) x 400 mm, 500 mm, 600 mm (d). An easy to install and use merchandizing tool to maximize sales and product visibility.

Other sizes available.

**Color:** Gr  
**Packaging:** 1 pc.

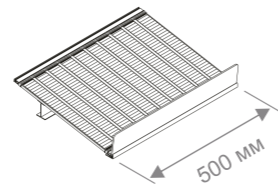

SHELF DEPTH / MM	CODE
400	280105
500	280145
600	280146



**FR-SHEET**      **FORTA ROLLER Sheet**

Ready assembled sheet 1000 (w) x 400 mm, 500 mm, 600 mm (d). An easy to install and use merchandizing tool to maximize sales and product visibility.

Other sizes available.

**Color:** Gr  
**Packaging:** 1 pc.

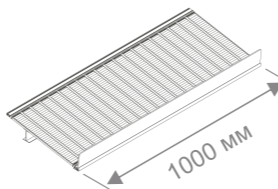

SHELF DEPTH / MM	CODE
400	280100
500	280129
600	280132



**FR-SHEET**      **FORTA ROLLER Sheet**

Ready assembled sheet 1250 (w) x 400 mm, 500 mm, 600 mm (d). An easy to install and use merchandizing tool to maximize sales and product visibility.

Other sizes available.

**Color:** Gr  
**Packaging:** 1 pc.

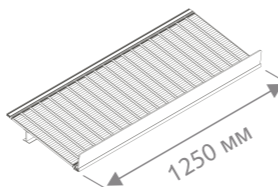

SHELF DEPTH / MM	CODE
400	280101
500	280130
600	280133



**FR-SHEET**      **FORTA ROLLER Sheet**

Ready assembled sheet 1330 (w) x 400 mm, 500 mm, 600 mm (d). An easy to install and use merchandizing tool to maximize sales and product visibility.

Other sizes available.

**Color:** Gr  
**Packaging:** 1 pc.

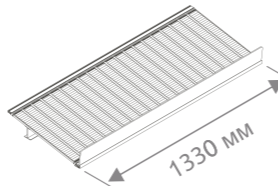

SHELF DEPTH / MM	CODE
400	280106
500	280131
600	280134

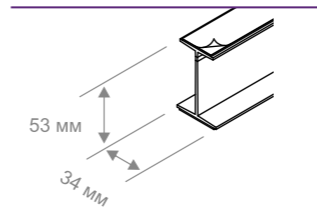

**2T-RAIL**      **FORTA ROLLER double-T rail with hinge**

The profile is used to create the necessary gliding angle for the roller sheet. Fixed to the roller sheet with foam tape, has magnetic tape to fix it to the shelf. The hinge function allows angle variation.

**Color:** Wh  
**Packaging:** 1 pc.

LENGTH / MM	CODE
500	280107
1000	280102
1250	280103
1330	280108

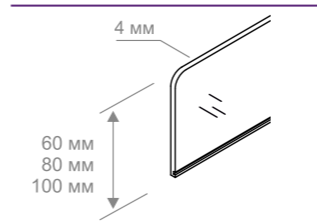

**FR-RISER**      **Front riser for FORTA ROLLER sheets**

Transparent front riser made of clear acrylic glass for a perfect product presentation and efficient work on the system - the riser prevents the product from falling.

**Color:** Tr  
**Packaging:** 1 pc.

HEIGHT H, MM	LENGTH / MM	CODE
60	500 / 1000 / 1250 / 1330	280109 / 280110 / 280111 / 280112
80	500 / 1000 / 1250 / 1330	280113 / 280114 / 280115 / 280116
100	500 / 1000 / 1250 / 1330	280117 / 280118 / 280119 / 280120

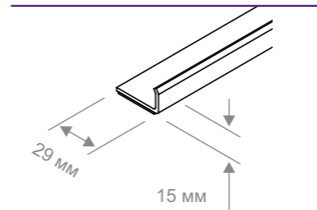

**L-RAIL15**      **FORTA ROLLER front limiter profiles**

Slim buy strong aluminum divider for use on roller sheets. 2 heights and different lengths available. Use our recommendations to choose the divider height.

**Color:** Tr  
**Packaging:** 1 pc.

LENGTH / MM	CODE
500	280125
1000	280125
1250	280127
1330	280128

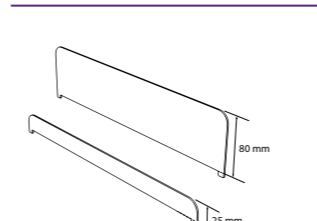

**ALU-DIV**      **Aluminum divider for FORTA ROLLER shelves**

Slim buy strong aluminum divider for use on roller sheets. 2 heights and different lengths available. Use our recommendations to choose the divider height.

**Color:** Gr  
**Packaging:** 10 pcs.

HEIGHT H, MM	SHELF DEPTH,MM	CODE
25	400 / 500 / 600	280121 / 280137 / 280138
80	400 / 500 / 600	280122 / 280139 / 280140

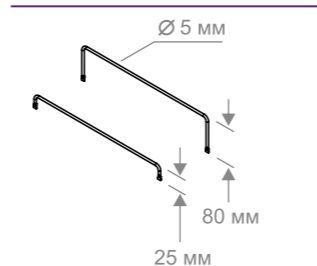
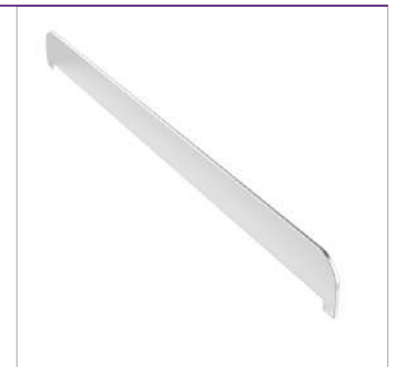

**MET-DIV**      **Metal divider for FORTA ROLLER shelves**

A sturdy metal divider, to be fixed on roller sheets. 2 heights and different lengths available. Recommended to use with heavy products.

**Color:** Gr  
**Packaging:** 10 pcs.

HEIGHT H, MM	SHELF DEPTH,MM	CODE
25	400 / 500 / 600	280123 / 280141 / 280142
80	400 / 500 / 600	280124 / 280143 / 280144



### FEEZELINE - PRODUCT PRESENTATION SYSTEM FOR FREEZERS







Keeping frozen products in deep freezers is often a challenge. The shoppers may find it difficult to find the product they want and they often complain that they cannot identify the price. Freezeline system is a good solution to solve these issues.

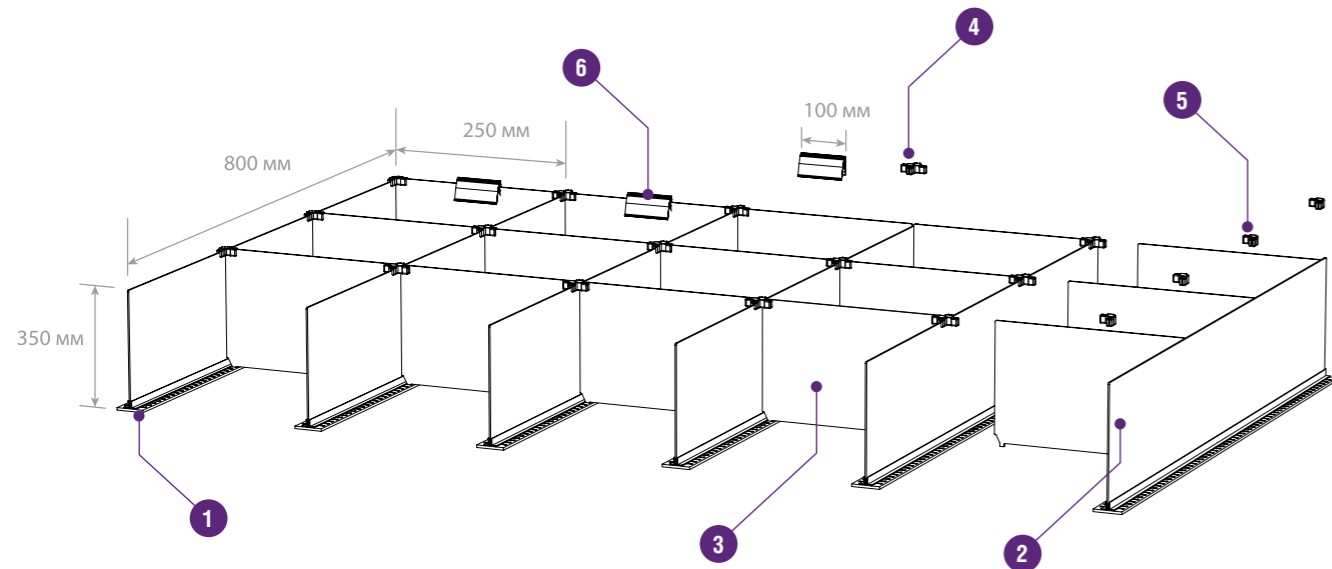

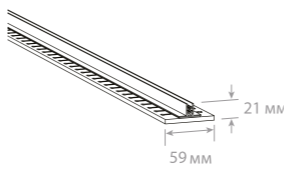
#### FREEZELINE SYSTEM COMPONENTS:

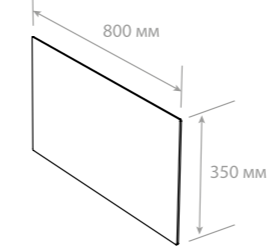
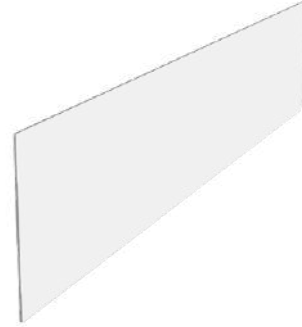
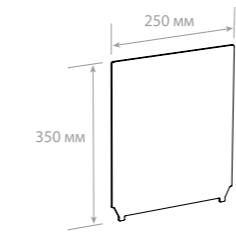
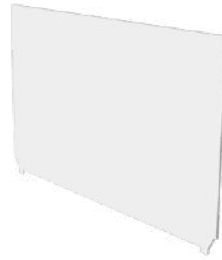
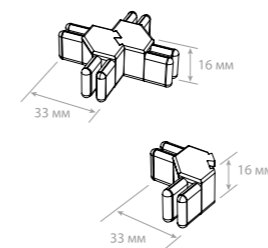
1. Perforated T-profile
2. Plastic divider
3. Plastic divider
4. Divider connector, X-type
5. Divider connector, L-Type
6. Pricer holder with hinge

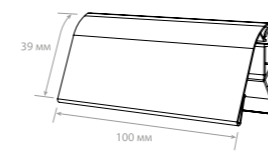

 <p><b>CODE</b> 300303</p>	<p><b>FZL-PROFILE</b>   Perforated T-profile</p> <p>Base profile for fixing dividers. Produced according to the freezer size.</p> <p><b>Color:</b> Wh</p>	
 <p><b>CODE</b> 300301</p>	<p><b>FZL-DIV</b>   Long divider</p> <p>Transparent divider made from 3mm thick PET sheet.</p> <p>Divider size is determined by the freezer dimensions the freezer planogram.</p> <p><b>Color:</b> Tr</p>	
 <p><b>CODE</b> 300302</p>	<p><b>FZL-DIV</b>   Short divider</p> <p>Transparent divider made from 3 mm thick PET. Connected with the long dividers with FZL-CLIP.</p> <p>Dimensions are determined by the freezer size and planogram.</p> <p><b>Color:</b> Tr</p>	
 <p><b>CODE</b> 300305</p>	<p><b>FZL-CLIP</b>   Divider connector</p> <p>These clips are used to connect the PET dividers. The clip is to be fixed on the top side of divider junction.</p> <p><b>Color:</b> Tr</p>	
 <p><b>CODE</b> 300300</p>	<p><b>FZL-PRICER</b>   Pricer with hinge</p> <p>This pricer allows to place the product price information right next to the product. The hinge function is convenient to avoid losing the price.</p> <p>Height: 39 mm Width: 100 mm</p> <p><b>Color:</b> Tr</p>	



## 2

## PLASTIC FRAMES AND FIXING ACCESSORIES



- 30 Display sets with plastic frames
- 36 INFOSTAND-XL STANDS
- 38 Plastic frames and poster protection sleeves
- 40 Fixing accessories for plastic frames
- 46 Tubes and T-holders
- 49 Plastic, metal and magnetic stand bases
- 52 MINI frames and fixing accessories
- 56 Shopping trolley frames
- 57 Info display flip frames
- 58 Flip information displays

# UNIQUE DISPLAY SETS STANDARD DISPLAY COMPONENTS

PF-A4 **102004-10**  
PP A4 **101014**  
T-S **102255-9-10**  
TEL-ALUTUBE **101008-xx**  
BASE-ML **101009-10-M6**  
A5, A4, A3



PF-A4 **102004-10**  
PP A4 **101014**  
T-S **102255-9-10**  
TEL-ALUTUBE **101007-xx**  
BASE-PL **102151-10**  
A5, A4



PFT **102572**  
PP A4 **101014**  
TEL-ALUTUBE **101006-xx**  
BASIS **102563**



PF-A3 **102003-03**  
PP A3 **101013**  
T-S **102255-9**  
TEL-ALUTUBE **101007-xx**  
BASE-ML-ROUND **102146-03-TB**  
A5, A4, A3

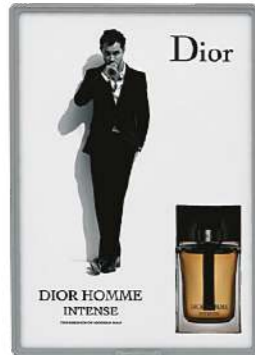

PF-A5 **102005-03**  
PP A5 **101015**  
T-S **102255-9**  
TEL-ALUTUBE **101006-xx**  
BASE-PL **102151-03**  
A5, A4



MGT-SW **102171**  
PF-A5 **102005-00**  
PP A5 **101015**  
A6, A5, A4



FIX-SW **102059**  
PF-A6 **1102006-04**  
PP A6 **101016**  
A6, A5, A4

FRAME CLAMP **102099**  
PF-A6 **102006-07**  
PP A6 **101016**  
A6, A5, A4



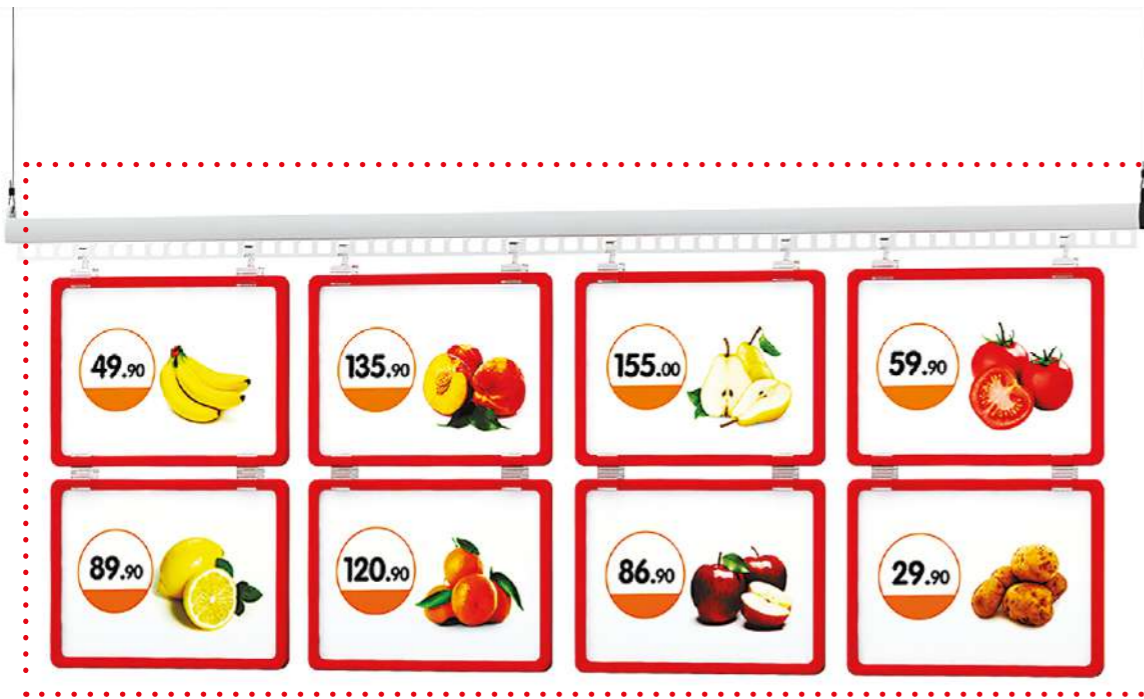

UNITRACK 282025-2000  
UNI-LINE 282020-1000  
UP-CLIP 102193  
PF-JOIN 102053  
PF-A4 102004-06  
PP A4 101014

PF-A4 102004-06  
PP A4 101014  
BASE-75 102095

PF-A5 102005-xx  
PP A5 101015  
CLAMP-T 102186-00

PF-A5 102005-xx  
PP A5 101015  
CLAMP-T 102186-10



PF-A4 102004-06  
CP-CLIP-SET 102776



TF-A4 102035-xx



PF-A4 **102004-xx**  
 PP A4 **101014**  
 MAGNET-00 **102061**

PF-A4 **102004-xx**  
 PP A4 **101014**  
 MAGNET-90 **102063**



BASE-PL **102151-xx**  
 ALUTUBE **101050-0300**  
 ST-HOLDER **202281**  
 TECHNO-VL **202120**  
 TM 1/4 A4 **112060-00**

BASE-PL **102151-xx**  
 ALUTUBE **101050-0300**  
 ST-HOLDER **202281**  
 CARDCLAMP-VL **202013**  
 BB A6 **101043**

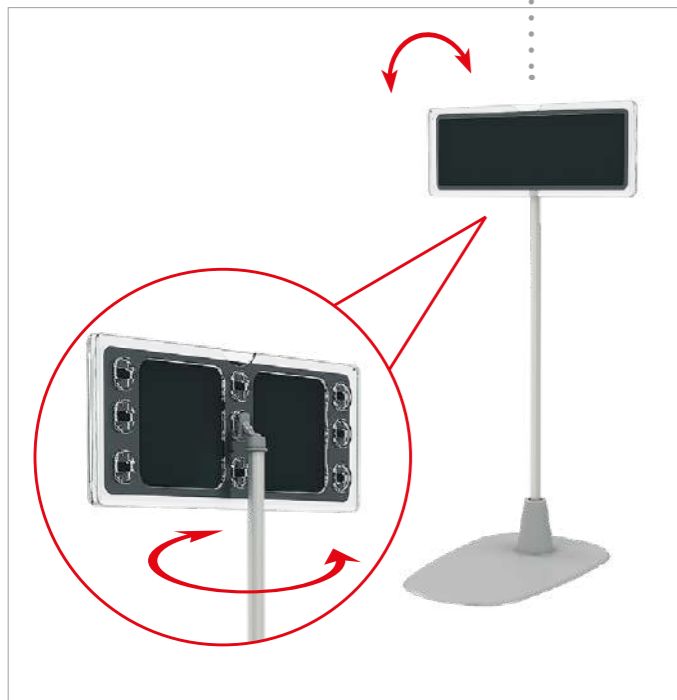

TM 1/4 A4 **112060-00**  
 TECHNO COIL CLIP **112064**

TM A8, TM A7, TM 1/3 A4, TM 1/4 A4

TM A8 **112077-xx**  
 TECHNO TEGO CLIP **112065**

TM A8, TM A7, TM 1/3 A4, TM 1/4 A4

TM A7 **112061-xx**  
 TECHNO SUPPORT CLIP **112066**

TM A8, TM A7, TM 1/3 A4, TM 1/4 A4

TM 1/3 A4 **112076-xx**  
 TECHNO SUPPORT CLIP **112066**

TM A8, TM A7, TM 1/3 A4, TM 1/4 A4

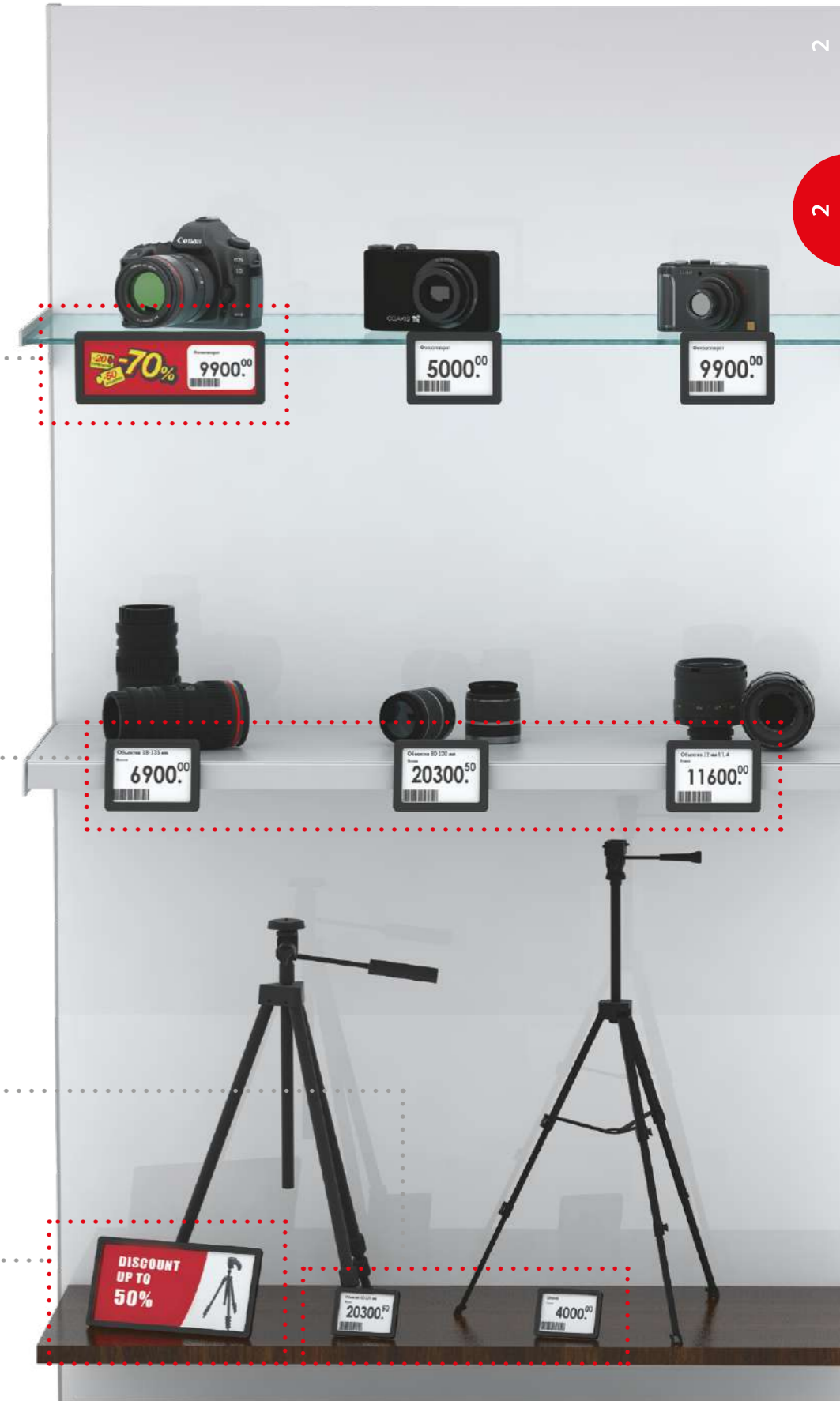

**INFOSTAND-XL STANDS**

When you need a higher and more stable information stand, we recommend to consider stands of this type. They have a bigger metal base, longer and thicker aluminum telescopic tube and a variety of frame holders.

**Cherry**  
25,-/PACK  
button 24

**DOWNY**  
(1 LITER)  
~~24<sup>99</sup>~~  
**15<sup>99</sup>**

**CLASS CLEANER**  
(2 LITER)  
~~34<sup>00</sup>~~  
**26<sup>50</sup>**

BASE-XL-ROUND **105112**  
FRAME HOLDERS A3 Duo **102773**  
TEL-ALUTUBE-XL **101548**  
PF-A3 **102003-00**

PF-A3 **102003-00**  
FRAME HOLDERS A3 **102772**  
TEL-ALUTUBE-XL **101548**  
BASE-XL-ROUND **105112**

Chocolate set 263 **180**

Candles set 359 **289**

Candle holder 290 **225**

Toy car 575 **459**

**GIFT IDEAS**

**GIFT IDEAS**

BASE-XL-ROUND **105112**  
ALUTUBE 20 mm **101549**  
PF-A4 **102004-00**  
JOKER CLIP **102402**

T-XL **102771**  
BASE-XL-ROUND **105112**  
TEL-ALUTUBE-XL **101548**  
PF-A3 **102003-00**

BASE-XL-ROUND **105112**  
FRAME HOLDERS A3 Duo **102773**  
TEL-ALUTUBE-XL **101548**  
PF-A3 **102003-00**

**SALE**  
**28<sup>50</sup>**  
OLD PRICE 35<sup>00</sup>

**30<sup>50</sup>**  
OLD PRICE 37<sup>00</sup>

**Pomegranate**  
button 38  
28,-/KG

**PLASTIC FRAME PF**

Plastic frames are simple and effective information holders. They are widely used as a part of display and suspension systems, on information boards and stands in shops.

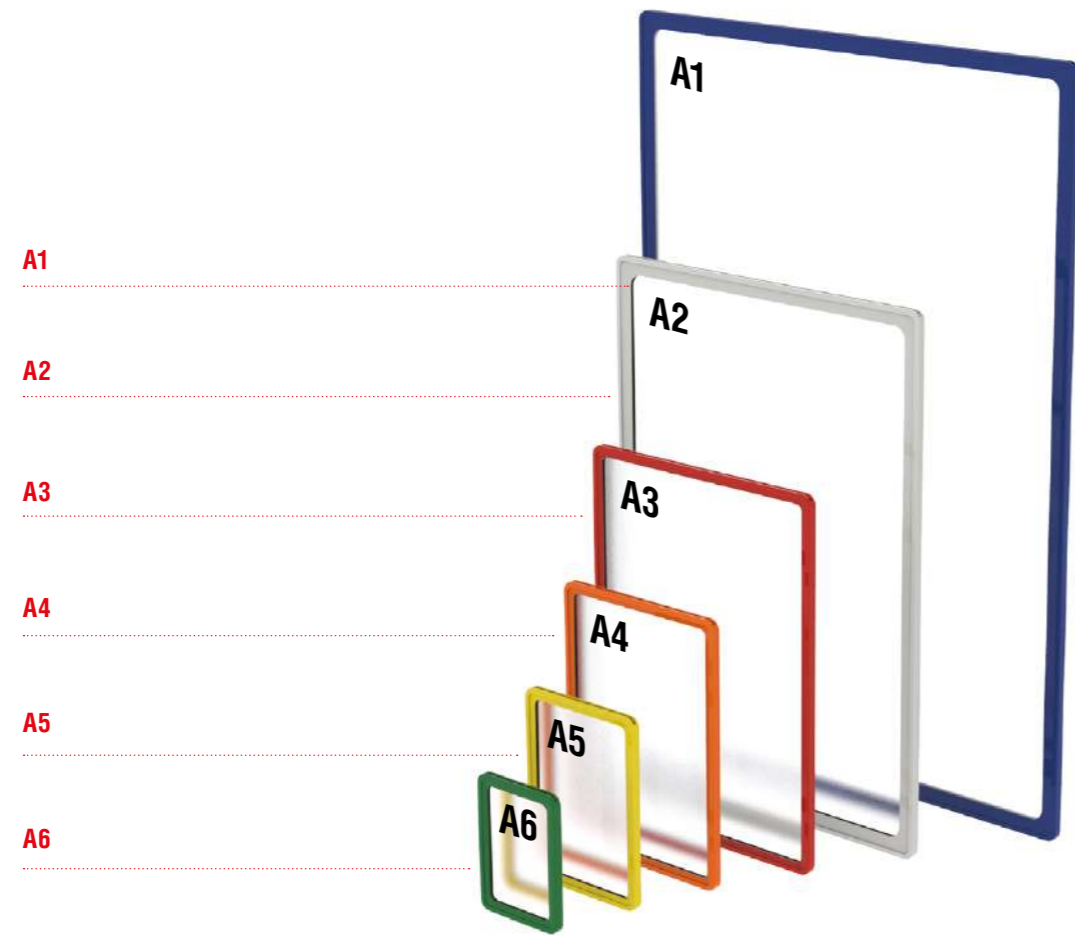

A1  
A2  
A3  
A4  
A5  
A6

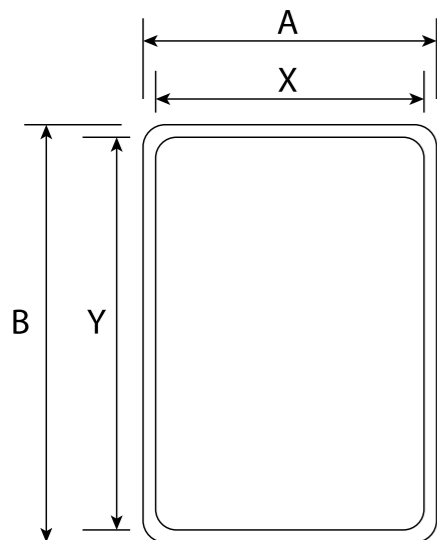

COLOR / FORMAT	A 1	A 2	A 3	A 4	A 5	A 6
Transparent	102001-00	102002-00	102003-00	102004-00	102005-00	102006-00
White	102001-01	102002-01	102003-01	102004-01	102005-01	102006-01
light gray	102001-03	102002-03	102003-03	102004-03	102005-03	102006-03
Yellow	102001-04	102002-04	102003-04	102004-04	102005-04	102006-04
Orange	102001-05	102002-05	102003-05	102004-05	102005-05	102006-05
Red	102001-06	102002-06	102003-06	102004-06	102005-06	102006-06
Green	102001-07	102002-07	102003-07	102004-07	102005-07	102006-07
Blue	102001-28	102002-28	102003-28	102004-28	102005-28	102006-28
Black	102001-10	102002-10	102003-10	102004-10	102005-10	102006-10

Poster size (X-Y)	594x841 MM	420x594 MM	297x420 MM	210x297 MM	148x210 MM	105x148 MM
Frame size (AxB)	601x858 MM	427x609 MM	304x427 MM	217x305 MM	154x219 MM	112x154 MM

**POSTER PROTECTION SLEEVE PP**

Transparent poster protection sleeve for plastic frames from A6 to A1 size.

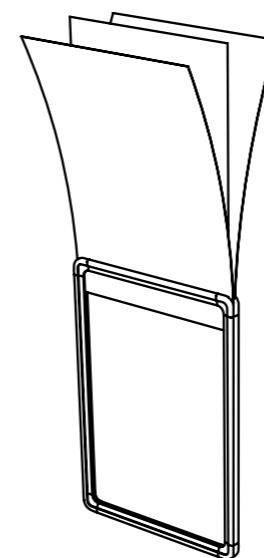
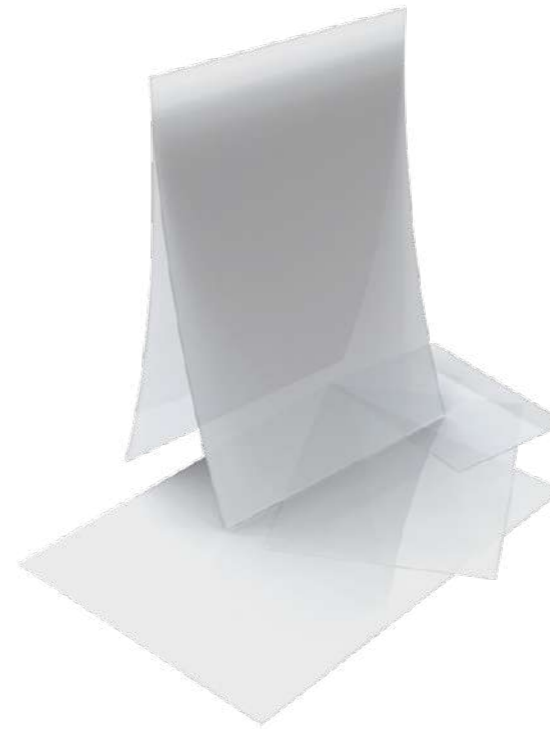

Since most of the signs and posters are printed on thin paper, it is required to protect them from damage and falling out. Using poster protection sleeve perfectly solves this problem.

Thickness: 0,2 mm.

Color: Tr

Packaging: 10 pcs.

CODE	FORMAT	SIZE (MM)
101016	A6	105 x 148
101015	A5	148 x 210
101014	A4	210 x 297
101013	A3	297 x 420
101012	A2	420 x 594
101011	A1	594 x 841

### FIXING ACCESSORIES FOR PLASTIC FRAMES

A wide range of accessories fitting all our plastic frames from A6 to A1 allows to use frames in nearly every situation of a modern store environment. All items are on stock, mass production ensures low price on these products.



**MAGNET-00** Plastic frame magnetic holder

Plastic frame magnetic holder. Fixes frames at 0° angle. This is required when you need to fix the frame parallel to the surface. Depending on the frame size, minimum 2 holders per frame are required.

Color: **Wh** **Sc**  
Packaging: 10 pcs.

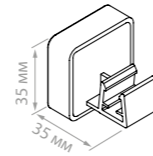

COLOR	CODE
White	102061
Black	102394



**MAGNET-90** Plastic frame magnetic holder

Plastic frame magnetic holder. Fixes frames at 90° angle. Depending on the frame size, minimum 2 holders per frame are required.

Color: **Wh** **Sc**  
Packaging: 10 pcs.

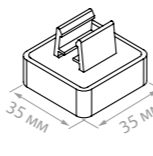

COLOR	CODE
White	102063
Black	102393



**MAGNET-MINI** Small plastic frame magnetic holder

This is a smaller holder, compared to the MAGNET-90/00, but it is a good solution when you need to fix a frame on a small metal surface (e.g. a metal tube). You can adjust the holder position vs base. Recommended to use with A6, A5, A4 frames.

Color: **Wh** **Sc**  
Packaging: 10 pcs.

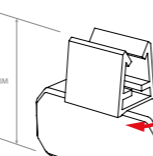

COLOR	CODE
White	102553
Black	102555



**MGT-SW** Swivel magnetic holder

Swivel magnetic holder for using plastic frames as shopper stoppers.

Color: **Wh** **Tr**  
Packaging: 10 pcs.

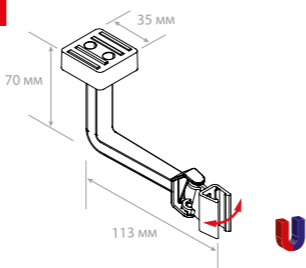

CODE
102171

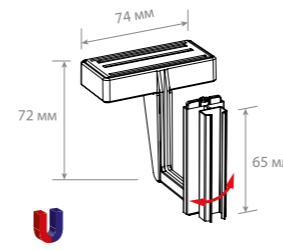

**MAG-FLEX-PF** Vertical plastic frame holder with strong magnet

This strong magnetic frame holder is fixed from the bottom or top part of the shelf. It is a great tool to attract attention to featured products or segment product in the category.

Recommended to use with A6, A5 or A4 frames.

Color: **Wh**  
Packaging: 10 pcs.

CODE
102580

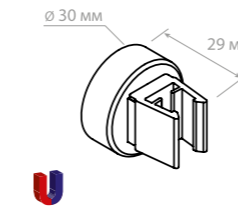

**MGT-RND-90** Round magnetic holder

Round magnetic holder for plastic frames. Fixes frames at 90° angle.

Color: **Wh**  
Packaging: 10 pcs.

CODE
102202

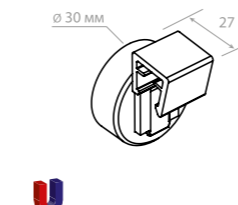

**MGT-RND-00** Round magnetic holder

Round magnetic holder for plastic frames. Fixes frames at 0° angle.

Color: **Wh**  
Packaging: 10 pcs.

CODE
102227

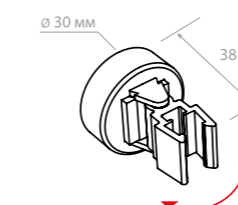

**MGT-RND-180** Round magnetic holder

Round magnetic holder for plastic frames with a ratchet grip. Fixes frames at different angles.

Color: **Wh**  
Packaging: 10 pcs.

CODE
102228

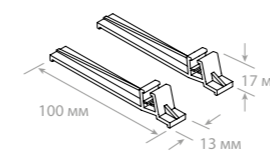

**BASE-75** Support clip

Support clip for angled positioning (15° incline) of plastic frames. Always recommended to use 2 clips per frame. Best if used with frames up to A3.

Color: **Tr**  
Packaging: 20 pcs.

CODE
102095





**BASE-90** Support clip

Support clip for straight positioning of plastic frames. Always recommended to use 2 clips per frame. Best if used with frames up to A3.

**Color:** Tr  
**Packaging:** 20 pcs.

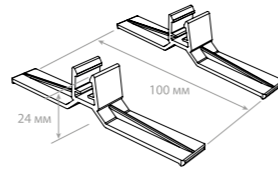

**CODE**  
102097



**FRAME CLAMP** Ratchet clip

Universal ratchet clip for fixing plastic frames on shelves, box and basket edges. The ratchet allows to fix the frame at a certain angle for better price tag presentation. Recommended to use with A6, A5 and A4 frames.

**Color:** Tr  
**Packaging:** 10 pcs.

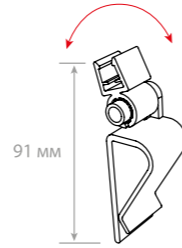

**CODE**  
102099



**CLAMP-T** Frame holder

Big clamp with integrated T-holder for plastic frames. Recommended to use with A6, A5, A4 frames. The T-holder with locks makes frame mounting easy, the soft clamp inlays ensure perfect grip on tubes.

**Color:** Tr Sc  
**Packaging:** 10 pcs.

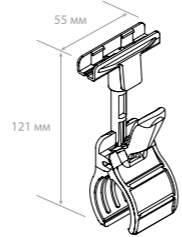

COLOR	CODE
Transparent	102186-00
Black	102186-10



**CLAMP-T-SW** Swivel frame holder

Swivel big clamp with integrated T-holder for plastic frame. The swivel ensures the possibility to adjust the angle of plastic frames from 0 to 180°.

**Color:** Tr  
**Packaging:** 10 pcs.

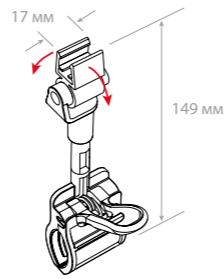

**CODE**  
102233



**FIX-SW** Metal clamp

Powder coated metal clamp with 2 swivel plastic frame holders. The clamp can be fixed on any shelf up to 35mm thick. Recommended to use with A6,A5,A4 frames

**Color:** Wh  
**Packaging:** 10 pcs.

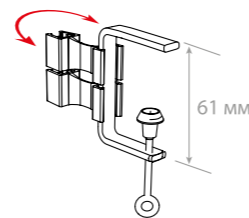

**CODE**  
102059

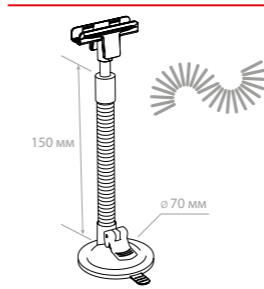

**SC-FLEX-T** Frame holder with strong suction cup

This holder is designed to fix plastic frames on any glass, plastic or metal surfaces when the position adjustment is needed. The strong suction cup at the base sticks well to the surface, while the flexible rod can be bent in any direction to achieve the necessary holding position.

**Color:** Wh  
**Packaging:** 10 pcs.

**CODE**  
252766

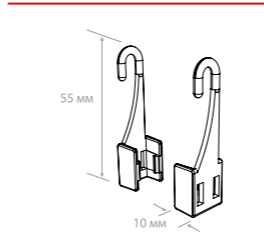

**F-CLIP** Swivel hanging hook clip

Swivel hanging hook clip for plastic frames suspension with a metal hook. Fixed on the left and right side of the frame, used in combination with ECOTRACK and UNITRACK suspension systems or wire baskets. Always used 2 hooks per frame (left and right).

**Color:** Tr  
**Packaging:** 20 pcs.

**CODE**  
102049

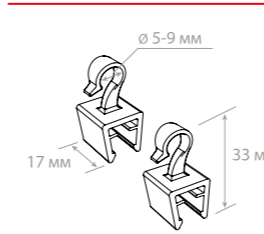

**UP-CLIP** Frame hook clip

Hanging hook clip for plastic frames suspension. Fixed on top side of the frame, used in combination with ECOTRACK and UNITRACK suspension systems. Fits the 9mm tube ( e.g. used in combination with a magnetic sign holder - MAG-SW-TUBE-L ). Always used 2 hooks per frame.

**Color:** Tr  
**Packaging:** 20 pcs.

**CODE**  
102193

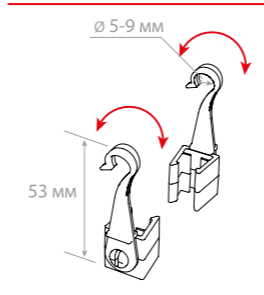

**F-CLIP-SW** Swivel hanging hook

Swivel hanging hook clip for plastic frames suspension. Fixed on the left and right side of the frame, used in combination with ECOTRACK and UNITRACK suspension systems. Always used 2 hooks per frame (left and right).

**Color:** Tr  
**Packaging:** 20 pcs.

**CODE**  
102051

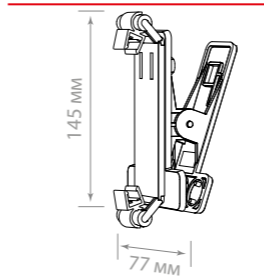

**V-CLAMP-PF** Double frame clamp holder

A great tool to organize pricing communication in Fruits & Vegetables Department. Recommended to use with two A6 frames, the frames color can be chosen from the standard range.

**Color:** Sc  
**Packaging:** 5 pcs.

**CODE**  
222408







**MF-CLIP** Swivel hanging hook clip

Swivel hanging hook clip for plastic frames suspension with a metal hook. Fixed on the left and right side of the frame, used in combination with ECOTRACK and UNITRACK suspension systems or wire baskets. Always used 2 hooks per frame (left and right).

**Color:** Tr  
**Packaging:** 20 pcs.

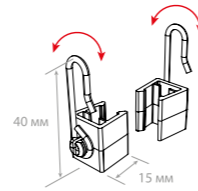

CODE
102215



**TUBE HOOK** Swivel hanging hook clip

Swivel hanging hook clip for plastic frames suspension. Fixed on the left and right side of the frame, used to hang frames on 18-24mm tubes. Always used 2 hooks per frame (left and right).

**Color:** Tr  
**Packaging:** 20 pcs.

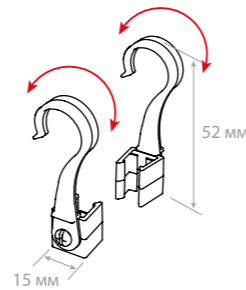

CODE
102189



**H-CLIP-SW** Suspension ring clip

Suspension ring clip for hanging plastic frames. Fixed on the upper side of the frame. The swivel ring part allows to adjust the ring. Always used 2 pcs clips per frame.

**Color:** Tr  
**Packaging:** 20 pcs.

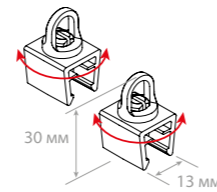

CODE
102047



**WB-CLIP 00** Foam tape clip for big frames

Strong and durable plastic clip for fixing plastic frames at 0(0) to the surface. Depending on the frame size you need 1 or 2 clips to fix one frame.

**Color:** Tr  
**Packaging:** 20 pcs.

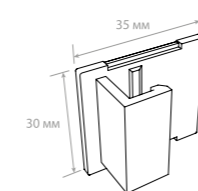

CODE
102298



**WB-CLIP 90** Foam tape clip for big frames

Strong and durable plastic clip for fixing plastic frames at 90(0) to the surface. Depending on the frame size you need 1 or 2 clips to fix one frame.

**Color:** Tr  
**Packaging:** 20 pcs.

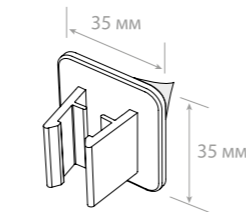

CODE
102297

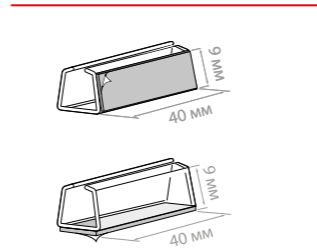

**FLU-CLIP** Clip with adhesive tape

Plastic clip for plastic frames fixing to any even surface at 0(0) and 90(0) angle. Depending on the frame size you need from 2 to 4 clips per frame.

**Color:** Tr  
**Packaging:** 20 pcs.

ANGLE	CODE
0	102067
90	102172

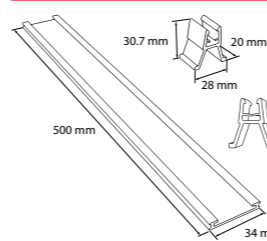

**CP-CLIP-SET** C-profile with vertical frame clip

This set is used to fix plastic frames vertically on any flat surface. Most commonly it is used on deep freezers to fix plastic frames to feature special deals. Recommended to use with A4 or A3 frames, with 2 clips per frame.

Profile standard length is 500mm, other lengths on request. The profile has foamed adhesive tape on the back side. The set consists of 10 plastic C-profiles (500mm each) and 20 clips.

**Color:** Tr  
**Packaging:** 10 pcs.

CODE
102776

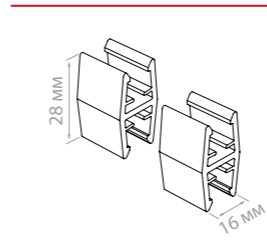

**PF-JOIN** Plastic frames connector

Plastic clip for plastic frames connection into multi-level sets. Can be used with frames of any size, the number of clips used depends on the set size.

**Color:** Tr  
**Packaging:** 20 pcs.

CODE
102053

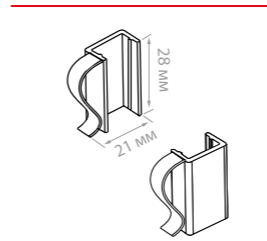

**B-CLIP** Wire basket clip

Plastic clip for fixing frames on wire baskets (e.g. a «Sale» or «Special offer» display). Always used 2 clips per frame (left and right).

**Color:** Tr  
**Packaging:** 20 pcs.

CODE
102195

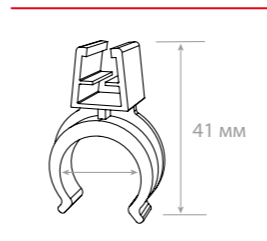
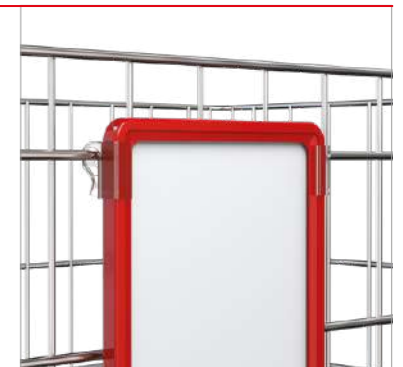

**JOKER CLIP** Tube clip

This clip is designed to fix plastic frames to metal and plastic tubes. We have to clip models - to fix frames to tubes with diameter 17-20mm and 22-25mm. Depending on the frame size you need 2-3 clips to fix one frame.

**Color:** Wh  
**Packaging:** 20 pcs.

TUBE DIAMETER, MM	CODE
22-25	102082
17-20	102402

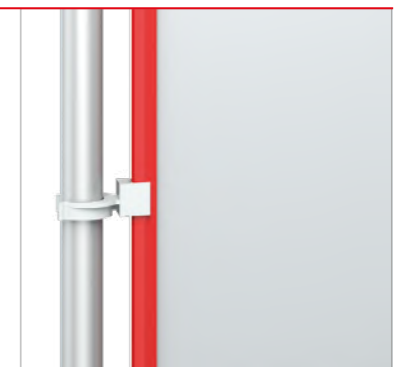



**INFO-CLIP** Info panel frame clip

This clip is used to transform a standard plastic frame into an information pane.  
Compatible with all plastic frames from our product range (from A6 to A1), 2 clips are needed per frame.

**Color:** Tr  
**Packaging:** 20 pcs.

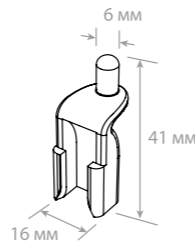

CODE
102075

**TUBES AND T-HOLDERS**

The wide choice of T-holders, bases and tubes provides the possibility to create combinations of any type – from simple solution for a shop to exclusive installations for banks or boutiques.

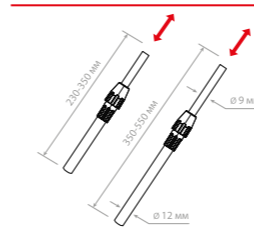

**TEL-LOCK-ALUTUBE** Aluminum telescopic tube with lock

These aluminum telescopic tubes have a connector with a lock that firmly blocks the 2 components of the tube.  
Recommended to use in stands with heavier signs and bigger frames.

**Color:** Gr  
**Packaging:** 10 pcs.

LENGTH, MM	ADAPTOR/TUBE COLOR	CODE
600-900	● / ● / ●	101558 / 101560 / 101566
1100-1400	● / ● / ●	101562 / 101564 / 101567

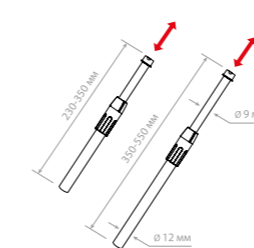

**TEL-ALUTUBE-STH** Aluminum telescopic tube with swivel connector

These telescopic aluminum tubes have a special connector at the top tip of the tube. You can attach different price holders and clamps from the Price holders «Swivel series».

**Color:** Gr  
**Packaging:** 10 pcs.

LENGTH, MM	CODE
230-350	101320
350-550	101352



**ALUTUBE** Aluminum tube

Aluminum tube. Length: 300 mm, other lengths – on request.  
Outer tube diameter 9 mm.

**Color:** Sl  
**Packaging:** 10 pcs.

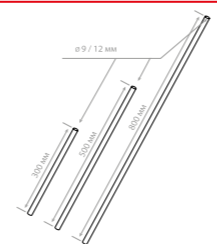

LENGTH, MM	CODE
300	101050-xx
500	101050-xx
800	101050-xx



**CROCS-FIX** Tube holder for wire baskets

With this tool you can easily fix plastic frames or sign holders on any wire mesh stands and baskets.  
The integrated telescopic tube allows to change the stand height within 180mm.  
You can use it with plastic frame T-holders (T-S) or other sign holders (SM-FIX, CB-FIX, ACR-HOLDER).

**Color:** Sl  
**Packaging:** 10 pcs.

CODE
102127



**TEL-ALUTUBE** Aluminum telescopic tube

Aluminum telescopic tube.  
Length: 350-550 mm, 600-900 mm, 1100-1400 mm.  
Outer tube diameter 9/12 mm.

**Color:** Sl Sc  
**Packaging:** 10 pcs.

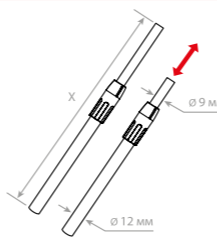

LENGTH X, MM	CODE, COLOR ● / ●
230-350	101000-xx
350-550	101006-xx
600-900	101007-xx
1100-1400	101008-xx

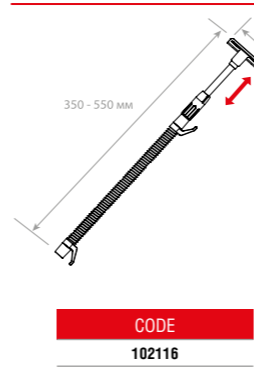

**CROCS-FIX-T** Plastic frame holder for wire baskets

With this tool you can easily fix plastic frames on any wire mesh stands and baskets.  
The integrated telescopic tube allows to change the stand height within 180mm.  
Frame T-holder is included into the set.

**Color:** Sl  
**Packaging:** 10 pcs.

CODE
102116



**TEL-PL-TUBE** Plastic telescopic tube

Plastic telescopic tube. A cheaper solution compared to aluminum tubes. Recommended to use with light signs and plastic frames.  
Outer tube diameter: 9/12mm.

**Color:** Gr  
**Packaging:** 10 pcs.

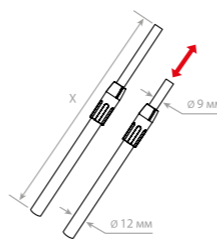

LENGTH, MM	CODE
230-350	101441
350-550	101442

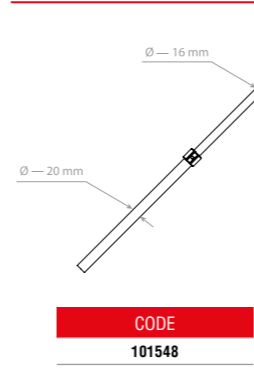

**TEL-ALUTUBE-XL** Large size aluminum telescopic tube (16/20mm)

This large size aluminum telescopic tube is used to make sign holding stands with EXTRA stands components and T-XL frame

**Color:** Sl  
**Packaging:** 10 pcs.

CODE
101548





**ALUTUBE 20 ALUMINUM TUBE**

Aluminum tube with plastic plug for EXTRA stands, to be used with JOKER CLIP (17-20mm version) and BASE-XL-ROUND metal base.

Standard length -1500mm (other lengths-on request).  
Outer diameter - 20mm.

**Color:** **Packaging:** 10 pcs.

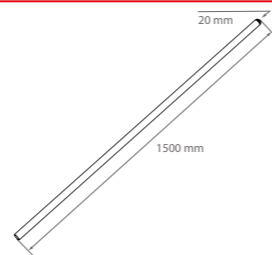

LENGTH, MM	CODE
1500	101549

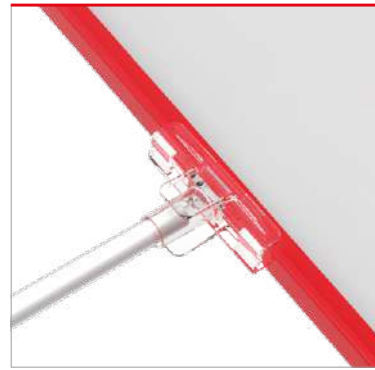

**T-S T-holder**

T-holder for plastic frames with side lock for easy frame connection. For 9mm diameter tubes.

**Color:** **Packaging:** 10 pcs.

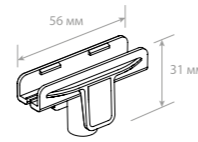

COLOR	CODE
Transparent	102255-9
Black	102255-9-10

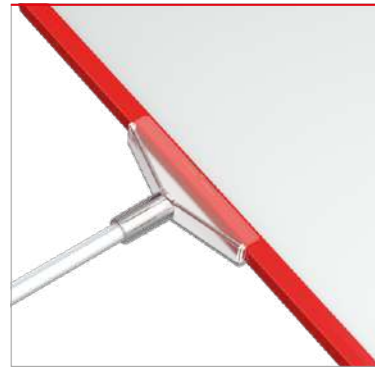

**T-L T-holder**

T-holder for plastic frames without side lock for 9 mm diameter tubes. The wider construction provides better grips for bigger frames (A3+).

**Color:** **Packaging:** 10 pcs.

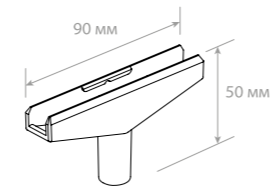

CODE
102117-xx

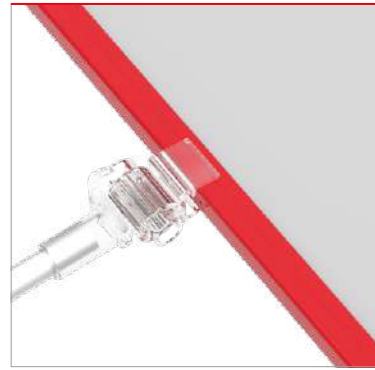

**SW-CLIP Swivel type T-holder**

Swivel type T-holder for plastic frames. The ratchet inside allows to fix the frame with a certain incline vs vertical position. Recommended to use with A6, A5 and A4 frames. For 9 mm diameter tubes.

**Color:** **Packaging:** 10 pcs.

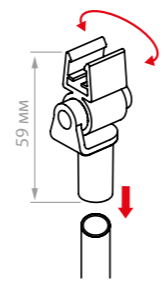

CODE
102229

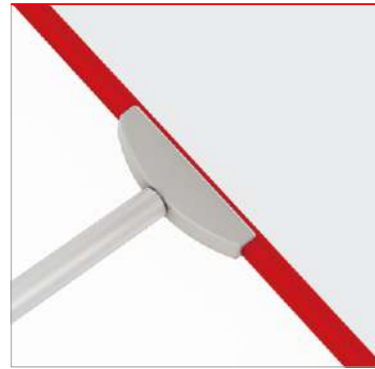

**T-XL T-HOLDER FOR 16MM TUBES**

This T-holder fits the 16mm tubes when inserted inside the tube. Used with TEL-XL-ALUTUBE to create larger frame stands.

**Color:** **Packaging:** 10 pcs.

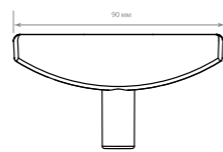

CODE
102771

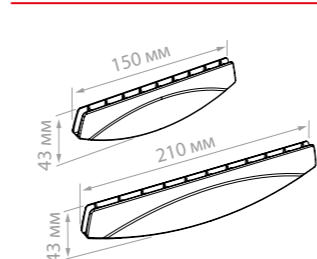

LENGTH, MM	CODE
150	102209
210	102210

**ACR-HOLDER Acrylic sign holder**

Holder for acrylic pockets or posters. The thickness of the insert - 3 mm.  
The width of the insert - 150 mm. It is possible to apply a logo. Used together with ALUTUBE 9 mm tubes, TEL-ALUTUBE, CLAMP holders, MAGNET-ROD

T-holder for plastic frames without side lock for 9 mm diameter tubes. The wider construction provides better grips for bigger frames ( A3+).

**Color:** **Packaging:** 10 pcs.

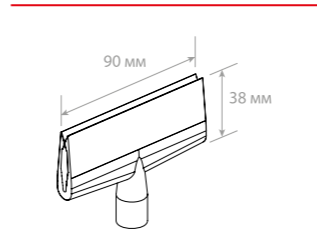

CODE
254151

**CB-FIX Universal poster holder**

Universal poster holder. Holds posters on thick paper, carton, plastic up to 4mm thick. Depending on the insert thickness holds poster up to A3 format. Can be used with 9 and 12mm diameter tubes..

**Color:** **Packaging:** 10 pcs.

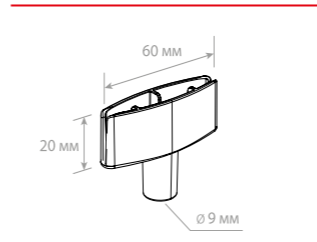
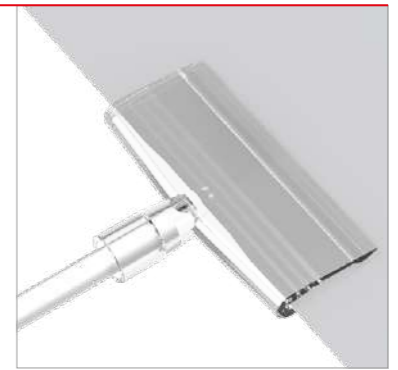

CODE
254584

**SM-FIX Plastic and carton sign holder**

This plastic holder is design to fix carton or plastic signs 1,2-1,5mm thick in stands with 9mm tubes (ALUTUBE, TEL-ALUTUBE), magnetic base MAGNET-ROD or CLAMP plastic clamp.

**Color:** **Packaging:** 10 pcs.

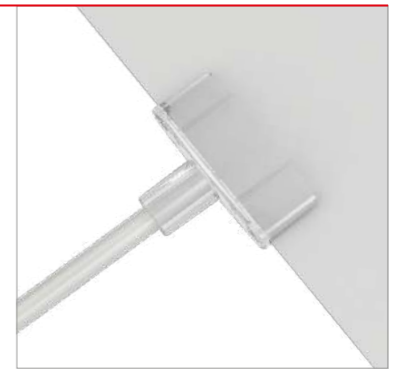

**PLASTIC, METAL AND MAGNETIC DISPLAY BASES**

The range of the display bases presented below allows you to create frame and sign stands of different size. Plastic stands are a cheaper version, while metal and magnetic bases provide more stability for the stand.

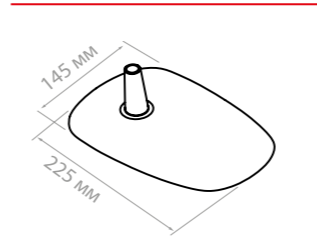

COLOR	CODE
Grey	102151-03
Black	102151-10

**BASE-PL Plastic base**

Plastic base. To be used with aluminum tubes 9 and 12mm in diameter. Best if used in combination with A6, A5 or A4 frames. For bigger frames a metal base is recommended

**Color:** **Packaging:** 10 pcs.





**BASIS** Rectangular plastic base

This plastic base is more stable compared to BASE-PL stand thanks to its shape. Recommended to use this short and medium-length tubes and frames up to A4. Different colors available.

**Color:** Gr Gn Re Sc Bl  
**Packaging:** 10 pcs.

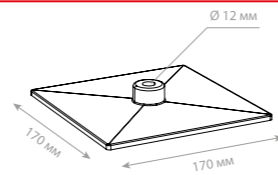

COLOR	CODE
Grey	102563
Black	102614
Red	102565
Green	102564
Blue	102567



**BASE-ML** Steel base plate

Steel base plate with rounded corners. Made of powder coated steel and plastic tube holder. To be used with 12 mm aluminum tubes.

**Color:** Sc Gr  
**Packaging:** 10 pcs.

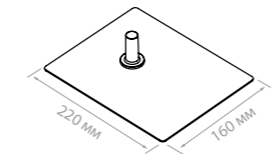

COLOR	CODE
Grey	101009-03-M6
Black	101009-10-M6



**BASE-ML-ROUND** Round metal base

This base is designed to create infostands with telescopic tubes and plastic frames or sign holders.

Base diameter - 180mm.  
 Tube holder fits tubes with 12mm diameter.

**Color:** Gr  
**Packaging:** 10 pcs.

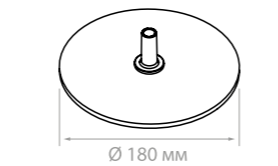

CODE
102146-03-TB



**BASE-MLH** Heavy metal rectangular base

Heavy metal base for higher infoholders. The bigger base size and thicker metal plate provide better stand stability.

Base size: 200x200mm.  
 Tube holder fits tubes with 12mm diameter.

**Color:** Gr  
**Packaging:** 10 pcs.

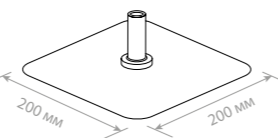

CODE
101010



**BASE-XL-ROUND** Big round metal base

This metal base is used with other EXTRA series components (20mm tube, frame holders) to create EXTRA info stands.

Base diameter : 310mm  
 The tube holder inner size: 20mm

**Color:** Sc  
**Packaging:** 10 pcs.

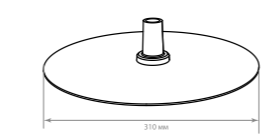

CODE
105112

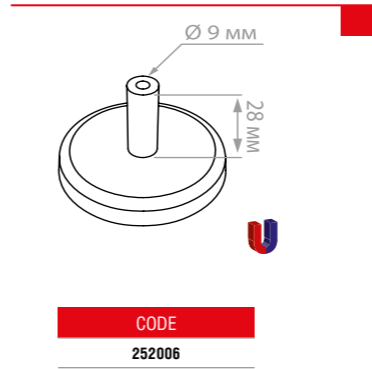

**MAGNET-ROD** Magnetic base for signs and frames

Magnetic base with 9mm rod to fix any holders fitting this size :  
 - plastic frame T-holder (T-S)  
 - acrylic sleeve holder ( ACR-HOLDER)  
 - universal sign holders (SM-FIX, CB-FIX)

**Color:** Sl  
**Packaging:** 10 pcs.

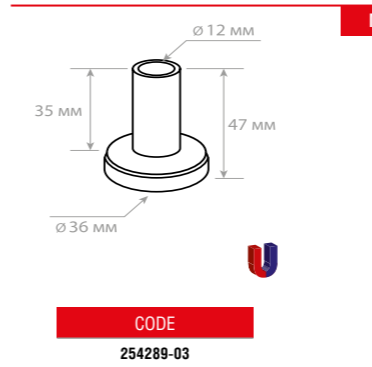

**MAG-STD-BASE** Magnetic base for sign holders

Used in combination with shorter aluminum telescopic tubes (230-350 mm and 350-550 mm ) and smaller signs or frames. The fitting tube required diameter - 12mm.

**Color:** Sl  
**Packaging:** 10 pcs.

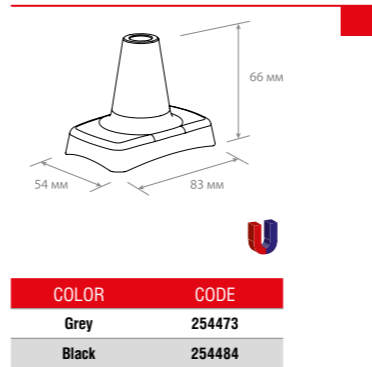

**MAG-XL-BASE** Strong magnetic base for sign holders

Tube holder on a powerful magnet for placing signs on vertical and horizontal surfaces. Used with 9 mm and 12 mm tubes ( not included in the set). The strong magnet holds signs of up to A3 size. 2 colors available.

**Color:** Gr Sc  
**Packaging:** 10 pcs.

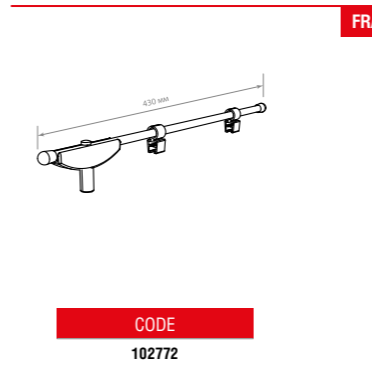

**FRAME HOLDERS A3** One side EXTRA frame holder

This component is used to create EXTRA frames stands with 1 frame.

To make a complete stand you will need a TEL-XL-ALUTUBE, an EXTRA-ML-BASE and a plastic frame ( A4 or A3).

**Color:** Gr  
**Packaging:** 10 pcs.

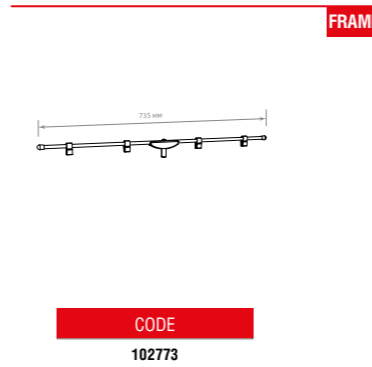

**FRAME HOLDERS A3 Duo** Two side EXTRA frame holder

This component is used to create EXTRA frames stands with 2 frames.

To make a complete stand you will need a TEL-XL-ALUTUBE, an EXTRA-ML-BASE and 2 plastic frames ( A4 or A3).

**Color:** Gr  
**Packaging:** 10 pcs.



**MINI PLASTIC FRAMES**

MINI frames is a great price communication tool when you need to highlight a limited number of products on shelf. It can be efficiently used in non-food shops, bakeries and coffee shops. It also works well to promote special offers - by using a frame of a different color.



If you want to fix a pricer or highlight a products on a glass shelf - MINI frames with TECHNO SUPPORT CLIP is a great solution !

The TECHNO SUPPORT CLIP is also can be combined with MINI frames to make stand-alone pricers.



MINI frames match really well with DELI series price holders making vivid pricers. Combine the colors of the holder and frame and add nice chalk writing !



Use the special price holder for ice beds - DELI-STICK-ICE - to mark pricing in the FISH department of your store.

A universal FX holder (plastic clamp) combined with A8 MINI frame creates an attractive pricer that can be fixed on a shelf, crate or basket. You can make signature pricers, combining different colors of the holder and frame.



The MINI frames can be fixed on glass or wooden shelves with TECHNO COIL CLIP or TECHNO SUPPORT CLIP. This works best fo electronics and other big products - when you have limited products on shelf and there is no need to use a datastrip.



With TECHNO COIL CLIP holder you can fix the MINI frames on most of the wooden shelves, thus making the problem of price marking in non-food stores solved.



### MINI FRAMES AND FIXING ACCESSORIES

When you need separate pricers with a variety of ways to fix them in the point of sale - MINI frames is definitely a great choice. With clips to fix them on metal, glass, wooden shelves they are a great tool to make your shop look nice and neat.



**TM A8** Plastic MINI frame A8

Shelftalker frames with several fixing points on different height to create different label combinations. Insert loading is done through the slot in the upper part of the frame

**Color:** Tr  
**Packaging:** 10 pcs.



**CODE**  
112077-xx



**TM A7** Plastic MINI frame A8

Shelftalker frames with several fixing points on different height to create different label combinations. Insert loading is done through the slot in the upper part of the frame

**Color:** Tr  
**Packaging:** 10 pcs.

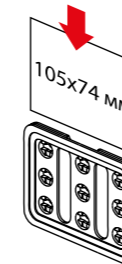

**CODE**  
112061-xx



**TECHNO SUPPORT CLIP** Clip for fixing a MINI frame

Clip for fixing a MINI frame on glass shelves and for making a freestanding price holder.

**Color:** Wh  
**Packaging:** 20 pcs.

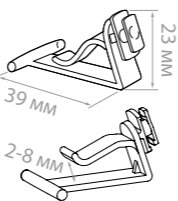

**CODE**  
112066



**TECHNO PERFO CLIP** Clip for fixing a MINI frame

Clip for fixing a MINI frame on a perforated surface ( distance between holes - 25mm) - e.g. perforated backwall of a shelving unit.

**Color:** Wh  
**Packaging:** 20 pcs.

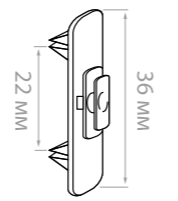

**CODE**  
112062

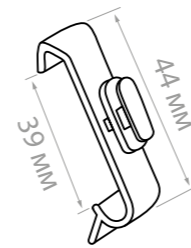

**TECHNO PRICER CLIP** Clip for fixing a Mini frame

Clip for fixing a MINI frame on 39mm datastrip front panel. Ideal to make easy to fix «Special offer»/ «New product» tags - right on the price strip.

**Color:** Wh  
**Packaging:** 20 pcs.

**CODE**  
112078

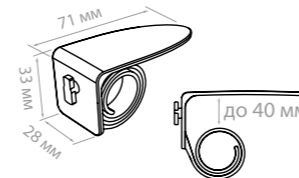

**TECHNO COIL CLIP** Universal coil clip for fixing Mini frames

Universal coil clip for fixing MINI frames on wooden, metal and glass shelves up to 40 mm thick.

**Color:** Tr  
**Packaging:** 20 pcs.

**CODE**  
112064

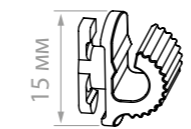

**TECHNO DELI CLIP** Adapter for mounting Mini frames to DELI price holders

Adapter for mounting MINI frames to DELI price holders. Recommended to use with A8 Mini frame.

**Color:** Tr  
**Packaging:** 20 pcs.

**CODE**  
112079



**TECHNO MGT-CLIP** Magnetic holder for mounting Mini frames

Magnetic holder for mounting MINI frames on metal surfaces.

**Color:** Tr  
**Packaging:** 10 pcs.

**CODE**  
112080

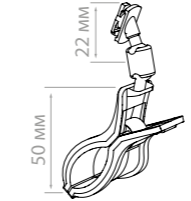

**TECHNO FX-CLIP** Swivel clip for fixing a mini frame

Clip for fixing MINI frames on different surfaces. Swivel holder provides the possibility to adjust the angle and position of the frame. To be used on the shelves and wires up to 25 mm thick.

**Color:** Tr  
**Packaging:** 10 pcs.

**CODE**  
112081



**PLASTIC FRAMES FOR SHOPPING TROLLEYS AND METAL WIRE BASKETS**

**TF-A4**

An efficient tool to advertize your product or special offers to the shoppers - the adds are always right in front of their eyes while shopping.



**TF-A4 Shopping trolley frame**

2-side frame set for metal shopping trolleys. Consists of 2 frames and 4 fixing clips. Insert size - A4, landscape layout.

**Color:** Wh Gr Ye Or Re Gn Bl Sc  
**Packaging:** 20 sets.

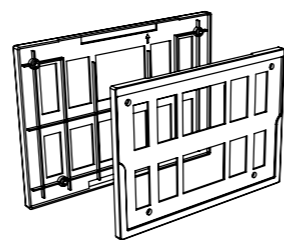

**CODE**  
102035-XX



**INFO-CLIP Info panel frame clip**

This clip is used to transform a standard plastic frame into an information pane. Compatible with all plastic frames from our product range (from A6 to A1), 2 clips are needed per frame.

**Color:** Tr  
**Packaging:** 20 pcs.

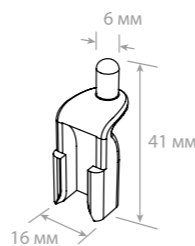

**CODE**  
102075

**INFO DISPLAY FLIP FRAMES**

Flip information displays are commonly used in shops, offices and points of sale to display product or service information to the customers. We offer a few solutions for this type of displays - frames with integrated infoclips (for frame fixture) or standard frames with add-on INFO-CLIPS.

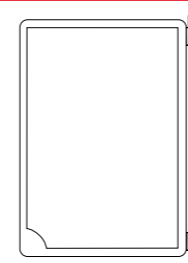

**INFOFRAME Display panes system frame**

Plastic frame with integrated clips for fixing frames in the holder. Recommended to use in combination with a transparent poster sleeve (not included). The inforced plastic corner makes page scrolling more convenient.

**Color:** Wh Gr Ye Or Re Gn Bl Sc  
**Packaging:** 10 pcs.

**CODE**  
152011-xx

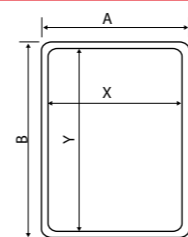

**PF Plastic frame**

You'll find all formats of plastic frames from A6 to A1. They can be produced from plastic of different colors. We present also a wide choice of holders and accessories to fix plastic frames on different surfaces and construction.

**Color:** Wh Gr Ye Or Re Gn Bl Sc

SIZE (MM)	CODE
A1	102001-XX
A2	102002-XX
A3	102003-XX
A4	102004-XX
A5	102005-XX
A6	102006-XX



### WALL FLIP INFORMATION DISPLAY INFOLINE-W

INFOLINE-W is an easy and efficient way to display multipage information in limited space. The standard holder is. The standard holder has fixtures for 10 frames, if you need more, you just put several holders next to each other.



Integrated clip to fix the frame



Changeable poster sleeve

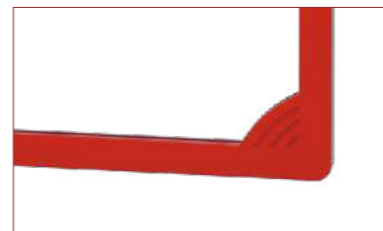

Inforced scrolling corner

### WALL FLIP INFORMATION DISPLAY POSTERLINE

Flip information display with big plastic frames (A3,A2, A1) is a good way to present posters, manuals big arrays of information (e.g. on information walls in showrooms, offices etc)



Firmly and securely wall fixing

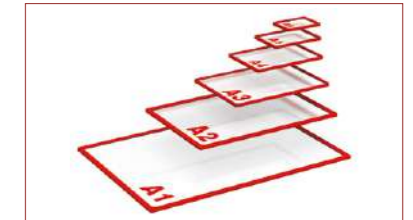

Wide sizes choice



Multiple colors available



INFOLINE-W

Flip frames metal holder

Metal holder for INFOFRAME flip frames. Fits 10 frames. Can be fixed where necessary with adhesive tape or screws.

**Color:** Gr  
**Packaging:** 1 pcs.

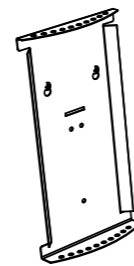

CODE  
152012



INFOFRAME

Info display flip frame

Plastic frame with integrated clips for fixing frames in the holder. Recommended to use in combination with a transparent poster sleeve (not included). The inforced plastic corner makes page scrolling more convenient.

**Color:** Wh Gr Ye Or Re Gr Bl Sc  
**Packaging:** 10 pcs.

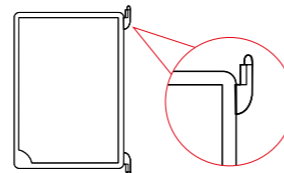

CODE  
152011-XX

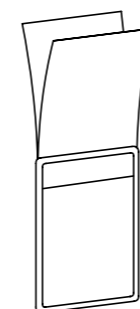

PF

Plastic frame

Standard plastic frames. Different sizes (A6 to A1) and colors available. Recommended to use with transparent poster sleeves.

**Color:** Wh Gr Ye Or Re Gr Bl Sc  
**Packaging:** 10 pcs.

SIZE (MM)	CODE
A1	102001-XX
A2	102002-XX
A3	102003-XX
A4	102004-XX
A5	102005-XX
A6	102006-XX

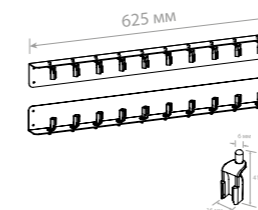

POSTERLINE WALL

Wall fixture set for plastic frames

The set consists of 2 metal L-shaped holders (upper and lower) and 20 plastic INFO-CLIPS. You can use it with plastic frames of any size since you can easily set the distance between the metal holders.

**Color:** Gr  
**Packaging:** 1 pcs.

CODE  
153073





**FLIP INFORMATION DISPLAY INFOLINE-ECO**

This durable and easy to use flip information display can be used in any point of sale to display multipage information about the products and services.

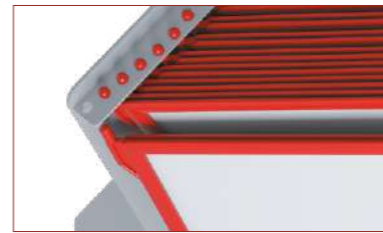

Integrated clip to fix the frame



Inforced scrolling corner



Ergonomic packaging

**FLOOR FLIP INFORMATION DISPLAY INFOLINE-F**

Universal tool to present multipage information when you only have floor level to be based on. Sturdy and reliable, height adjustable.

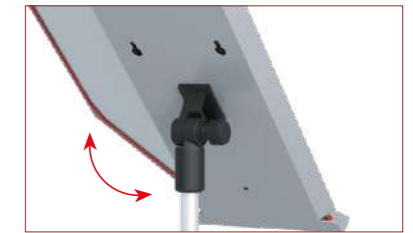

Incline angle change



Height adjustment



Ergonomic packaging

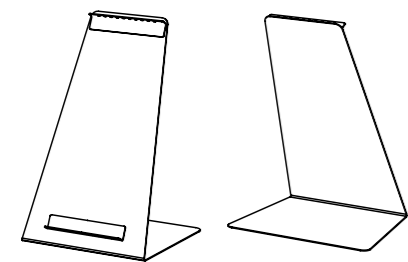
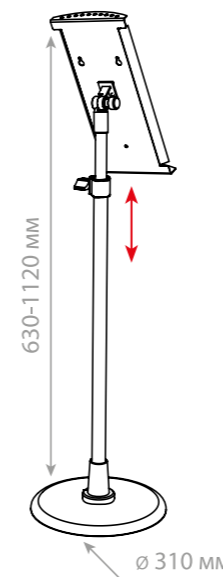

**INFOLINE-ECO** Info display flip frame

Sturdy and stable metal flip information display base for 10 A4 INFOFRAME frames. You can choose the frame color from the INFOFRAME color range.

**Color:** Gr  
**Packaging:** 1 pcs.

**CODE**  
153051

**INFOLINE-F** Floor flip information display

Floor flip information display base

**Color:** Gr  
**Packaging:** 1 pcs.

**CODE**  
153034

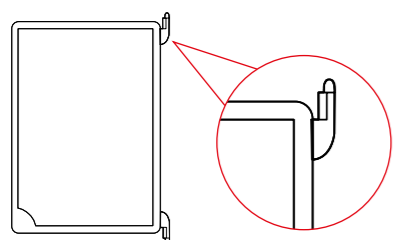

**INFOFRAME** Info display flip frame

Plastic frame with integrated clips for fixing frames in the holder. Recommended to use in combination with a transparent poster sleeve (not included). The inforced plastic corner makes page scrolling more convenient.

**Color:** Wh Gr Ye Or Re Gn Bl Sc  
**Packaging:** 10 pcs.

**CODE**  
152011-XX

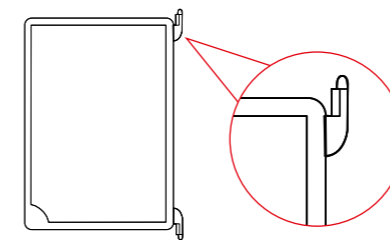

**INFOFRAME** Info display flip frame

Plastic frame with integrated clips for fixing frames in the holder. Recommended to use in combination with a transparent poster sleeve (not included). The inforced plastic corner makes page scrolling more convenient.

**Color:** Wh Gr Ye Or Re Gn Bl Sc  
**Packaging:** 10 pcs.

**CODE**  
152011-xx

## 3

## DATASTRIPS AND ESL HOLDERS

- 64 Datastrips with adhesive tape
- 65 Datastrips for wire shelves and baskets
- 66 Datastrips for metal shelves
- 68 Datastrips for glass and wooden shelves
- 68 Price label for hooks
- 69 Color-inserts
- 70 Electronic shelf label holders



### DATASTRIPS WITH ADHESIVE TAPE

Universal datastrips to be fixed on any even surface (metal, wood, glass, plastic). Widely used as an additional component (price holder) of product displays. Can be cut into shorter pieces to be used as separate priceholders.



#### DBR Universal datastrip with adhesive tape

The most universal datastrip with flat back surface and adhesive tape (standard of foam).

Label heights : 26,30,39,52,60,73,105  
Standard lengths: 1000,1250mm

Color:

Packaging: 100 pcs/box.

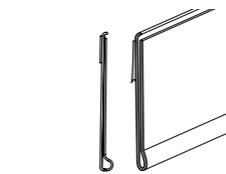

HEIGHT, MM	CODE
30	195001-xx
39	195002-xx
52	195020-xx
60	195030-xx
73	195126-xx



#### HEL Universal datastrip with adhesive tape

Mounted on top of the shelf, fixed with adhesive tape. Front part inclined at 20 degree angle.

Label height : 39mm.  
Standard lengths : 1000, 1250mm.

Color:

Packaging: 100, 10 pcs/box.

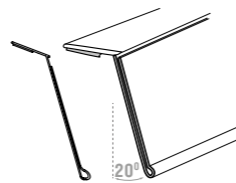

HEIGHT, MM	CODE
39	195005-xx



#### DHH Flip-up datastrip with adhesive tape

This datastrip can have very different applications – it can be fixed on the shelf edge and work as a flip-up price label holder or can be attached from beneath to other datastrip as a segmentation strip.

Label height – 39 mm.  
Standard lengths : 1000, 1250 mm.

Color:

Packaging: 10, 100 pcs/box.

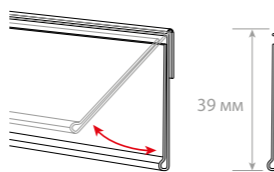

HEIGHT, MM	CODE
39	195766 / 195800



#### PR030 Curved branding profile

Curved branding profile with integrated T-rail. Can be used in combination with dividers (30 or 60 mm dividers are recommended), branding clips and sign clips. Ideal for making shelf segmentation and glorifying a brand on shelf.

Color:

Packaging: 10, 50 pcs/box.

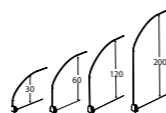

CODE
270034-xx

### DATASTRIPS FOR WIRE SHELVES AND BASKETS

You can choose the best solutions from our wide range of datastrips to fit different thicknesses of wire and to get the desired incline angle.

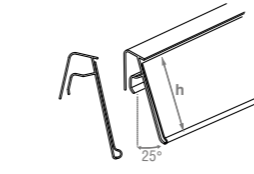

#### KE Datastrip for wire baskets

Price label holder for wire baskets with wire thickness 4-8 mm. Creates a slight incline of the label for easier price reading.

Label height: 39,60 mm.  
Standard lengths:1000, 1250 mm.

Color:

Packaging: 50 pcs/box.

HEIGHT, MM	CODE
39	195008-xx
60	196616

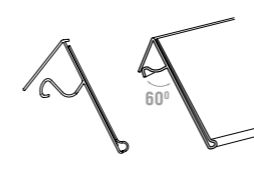

#### KOL Datastrip for wire baskets

Price label holder for wire baskets with wire thickness 4-8 mm. Creates a 45° incline of the label for easier price reading.

Label height: 39, 60 mm.  
Standard lengths: 1000, 1250 mm.

Color:

Packaging: 50 pcs/box.

HEIGHT, MM	CODE
39	195057-xx
60	196317 / 196447

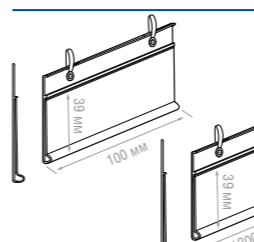

#### DBH Datastrip with hanging clips

Datastrips with holes in the upper part to be used with HM plastic hanging clips. Recommended to use 4-5 clips per meter of the datastrip. The clips are provided separately.

Label height: 39, 60 mm.  
Standard lengths: 100, 1000, 1250 mm.

Color:

Packaging: 50, 70, 100 pcs/box.

LENGTH	CODE
39	195004-xx-xxxx
60	196160 / 196212



#### DRA Label holder for wire shelves

Price label holders for wire shelves.

Label height: 39, 52, 60 mm.  
Standard lengths: 1000,1250 mm.

Color:

Packaging: 50 pcs/box.

HEIGHT, MM	CODE
39	195046-xx
52	195180-xx
60	195084-xx



### DATASTRIPS FOR METAL SHELVES

We have a wide range of price labels holders for most of the metal shelves existing on the market. We recommend to try datastrip samples on the specific shelf to ensure good hold.



**LST** Price label holder for TEGO, LINDE, STOREBEST type shelves

Fits all TEGO compatible shelves (Tegometall, Linde, Storebest, Mago etc). Makes 2 incline angles when fixed in different positions.

Label heights – 39, 60 mm.  
Standard lengths – 988, 1238, 1318 mm.

Color:

Packaging: 50 pcs/box.

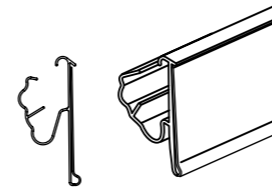

HEIGHT, MM	CODE
39	195016-xx
60	195032-xx



**TEN** Price label holder for TEGO type shelves

Fits all TEGO compatible shelves (Tegometall, Linde, Storebest, Mago etc).

Label heights – 39, 60 mm.  
Standard lengths – 988, 1238, 1318 mm.

Color:

Packaging: 50, 80 pcs/box.

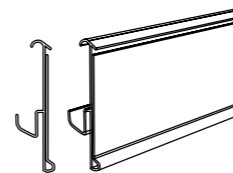

HEIGHT, MM	CODE
39	195011-xx
60	195133-xx



**UT** Price label holder for UCGE type shelves

Fits UCGE type shelves.

Label heights – 39,60 mm.  
Standard lengths – 985, 1235, 1315 mm.

Color:

Packaging: 50 pcs/box.

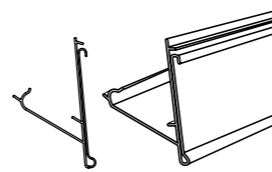

HEIGHT, MM	CODE
39	195044-xx
60	196314/196315/ 196316



**HSAC** Flip-up price label holder for shelves with 25mm C-channel

Curved price label holder for shelves with 25 mm C-channel (Hermes, La Fortezza and similar).

Standard height: 39,60 mm.  
Standard lengths: 988, 1238, 1318 mm.

Color:

Packaging: 50, 70 pcs/box.

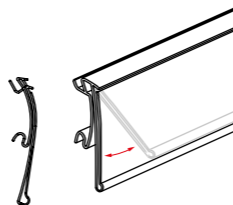

HEIGHT, MM	CODE
39	195003-xx
60	195164-xx / 195307

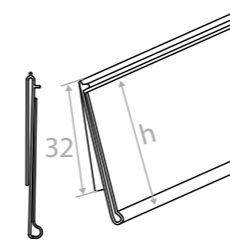

**IP** Price label holder for C-channel shelf front

Price label holders for shelves with C-channel (UCGE, ARNEG and similar).

Back plate height – 32 mm.  
Front label height – 39 mm.  
Standard lengths – 985, 1235, 1315 mm.

Color:

Packaging: 100 pcs/box.

HEIGHT, MM	CODE
39	195013-xx
60	195027-xx

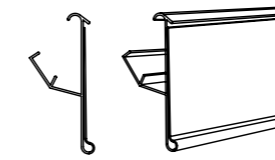

**LRY39** Price label holder for Modern Expo shelves

Price label holder for MODERN EXPO shelf. No flip-up function, 2 angle positions.

Standard lengths: 988, 1238, 1318 mm.

Color:

Packaging: 50 pcs/box.

CODE
195160-xx

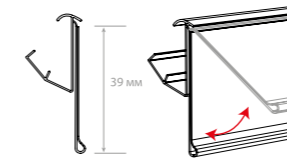

**LP39** Price label holder for Modern Expo shelves

Price label holder for MODERN EXPO shelves with flip-up function and 2 angle positions.

Standard lengths: 988, 1238, 1318 mm.

Color:

Packaging: 50 pcs/box.

CODE
196277 / 195226-00-0988

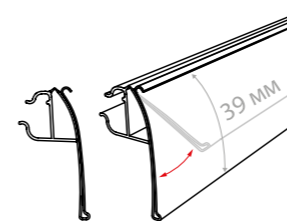

**FRW39** Price label holder for wire shelves

Price label holder with flip-up function for wire shelves with double wire shelf front. Fits WANZL and similar wire shelves.

Standard height: 39 mm.  
Standard lengths: 1000, 1250 mm.

Color:

Packaging: 50 pcs/box.

HEIGHT, MM	CODE
39	195876 / 195877

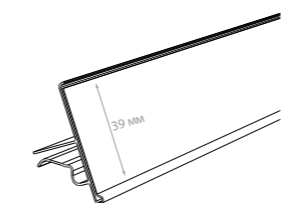

**CC39** Price label holder for fridge shelves

Fits shelves of many beverage fridge model. Works as a price label holder and front limiter to prevent bottles from falling.

Label height: 39 mm.  
Standard length: 520 mm, other lengths on request.

Color:

Packaging: 100 pcs/box.

HEIGHT, MM	CODE
39	195745



### DATASTRIPS FOR GLASS AND WOODEN SHELVES

Glass and wooden shelves are very common in pharmacies and non-food stores. We have several options of clip-on price label holders for this shelf types.



**GLS** Label holder for glass shelves

Fits most of the glass shelves on the market. The 20° incline ensures optimal price presentation.

Different sizes available.

Color: **Tr**

Packaging: 50 pcs/box.

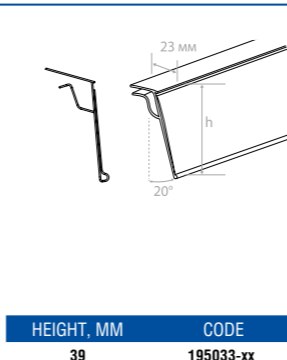

**ANT** Label holder for wooden shelves

Fits wooden shelves 20-30 mm thick. The front part incline ensures optimal price presentation.

Different lengths available.

Color: **Tr**

Packaging: 10, 25 pcs/box.

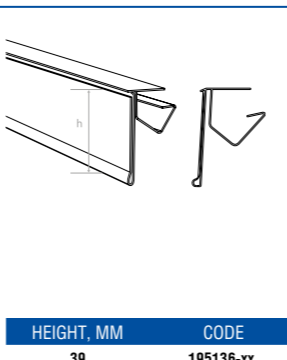

### PRICE LABELS FOR HOOKS

There are many hook types on the market, and we have a range of hook price label holders fitting most of them.



**VH** Flip-up label holder for hooks

Fixed on metal and plastic hooks. Has flip-up function.

Different heights and lengths available.

Color: **Tr**

Packaging: 100 pcs.

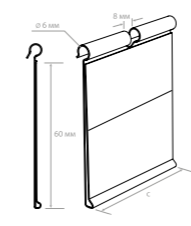
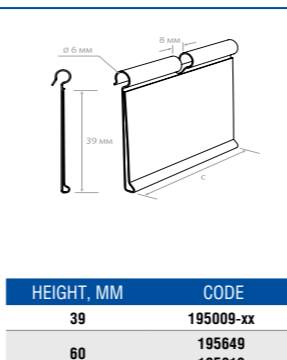

**VH39-39** Flip-up double label holder for hooks

Flip-up hook label holder with 2 label sleeves. This function can be used for segmentation or double pricing.

Standard width – 70mm, other sizes on request. Each label height – 39 mm.

Color: **Tr**

Packaging: 100 pcs.

LENGTH	CODE
50	197548
70	195194-00-0070

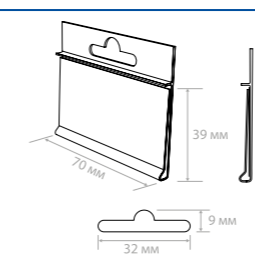

**DBHH** Hang-on label holder for hooks

Easy to use hang on version of hook label holder. Fits most of the single and double hooks on the market.

Label height - 39mm, width - 70mm. Other sizes on request.

Color: **Tr**

Packaging: 100 pcs.

HEIGHT, MM	CODE
39	195042



**PP-TAG** Injected label holder for hooks

Injected label holder for double metal or plastic hooks. To be fixed with a locking loop on hooks with wire from 4 to 6 mm thick.

Label size – 27x30 mm.

Color: **Tr**

Packaging: 100 pcs/box.

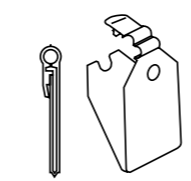

CODE
195010



### COLOR INSERTS

When you want a label cut off with special color and it is not on stock, using color inserts is a good solution. Just cut of a piece from the roll and insert it inside the standard white or transparent datastrip – and your product is ready.

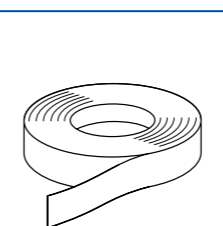

**COLOR-INSERT** Plastic color insert for label holders

Produced from thin plastic, to be used to achieve the desired color of datastrips.

The height of the inserts: 39 mm and 60 mm. 100 m in the roll.

Color:

Packaging: 1 roll.

HEIGHT	CODE
39 mm	195023-xx
60 mm	195117-xx



### ELECTRONIC SHELF LABEL HOLDERS

ESL (Electronic Shelf Labels) are no longer a futuristic novelty. They have become a standard solution for many supermarkets, making them more efficient, informative and modern looking.



#### WHY ESL (ELECTRONIC SHELF LABELS)?

- improve operations efficiency
- minimise pricing errors
- reduce labor costs
- improve customer perception of your store

#### WHY RIGHT ESL HOLDERS ARE SO IMPORTANT?

- minimise ESL theft
- minimise ESL damage
- ensure the labels are placed right
- maximise efficiency of you investment into ESL

#### WE OFFER A WIDE RANGE OF ESL HOLDERS:

- on shelf
- free-standing
- on hooks
- clip-on

### FREE STANDING AND CLIP-ON ESL HOLDERS

Choose from a big size, color and fixing mode variety of our ESL holders. We have solutions for nearly every situation and ESL type.



The big clamp is a sturdy and reliable solution to fix ESL on basket, crates or product displays. It can hold a wide range of ESL - up to A5 size !

Our free standing ESL holders have an appealing look, are very simple to use and store and have a very attractive price.

Check with us your ESL brand and type to make a list of possible fixing solutions for your task!



Our range of DELI and SWIVEL price holders can be easily converted into ESL holders. Multiple combinations and colors will definitely let you make your choice!

The big black clamp holder was originally designed for price cassettes. But it fits most of the ESL as well. It is a great choice for Fruit&Vegetable or Bread department.



### ESL HOLDERS FOR SHELVES

On shelf ESL holders are similar to the standard datastrips - they are fixed on shelf using their back side, their front side is a C-channel designed for specific electronic shelf labels.

They usually have a hinge to provide the holders with flip-up function.

#### ESL on-shelf holders for wire shelves



Wire shelves have got very common on many markets. We have solutions for ESL for the most common wire shelves in our range - depending on your ESL type and order size it will be a two-part profile (back and front sides) or a one-part extruded profile. The profiles can be cut according to your requirements.



#### ESL on-shelf holders for glass and wooden shelves



Glass and wooden shelves are mostly used in non-food stores: glass shelves are common in pharmacies and droggeries, while wooden shelves create a more nature-like look in a store of any type. The shelf thickness is the most important criterion to choose the right ESL holder. Depending on your ESL type and order size it will be a two-part profile (back and front sides) or a one-part extruded profile. The profiles can be cut according to your requirements.



#### ESL on-shelf holders for metal shelves



Thanks to their strength and loading capacity, metal shelves are used in every supermarket and hypermarket. We have solutions for ESL for the most common metal shelves in our range - depending on your ESL type and order size it will be a two-part profile (back and front sides) or a one-part extruded profile. The profiles can be cut according to your requirements.



To offer you the best solution we will need to know the brand and type of the ESL and the shelf specs.

We have a variety of options to offer to solve this task, each of them has their pros and cons - let our specialists define the one fitting your needs and your budget.

### ESL HOLDERS FOR HOOKS AND SUSPENSION

Fixing ESL holders on hooks is not an easy task. It is usually required to provide flip-up feature for the label, so the holder must hold the ESL tightly and ensure the right price display angle.

#### Flip-up label holder for hooks



This ESL on-hook holder is good for smaller ESLs, they are lighter and cheaper than extruded versions. These holders fit most of the hook T-rods, but we recommend to test specific holders with specific hooks and ESLs.



#### Flip up hook label holder with adjustable angle



This injected hook label holder consists of 2 main parts - 1) T-rod fixture with angle adjustment and 2) ESL clip. The 1st part is universal and fits most of the hooks present on the market. The 2nd part is a clip that fits the ESL of specific vendor (SES, Hanshow, Hanshow Nebular, Solum and others). Please, discuss with us the ESL that you want to fix to offer you the right set.



#### Plastic clips for ESL suspension



Injected plastic clips to fix the bigger size ESLs on wire mesh or metal rails. Depending on the ESL size, recommended to use 1 or 2 clips per tag. The clips have open loop, so you can use them to fix the ESL on the box or crate edge as well.



We have several extruded and injected solutions to fix ESL on hooks. To ensure tight fixing we need to know the ESL brand and type. Some injected solutions allow label angle adjustment that is a very good way to ensure perfect price presentation to consumers.

## 4

# PRICE LABEL HOLDERS AND PRICE CASSETTES



- 78 DELI price holders
- 82 Swivel price holders
- 88 Universal price holders
- 90 Big clamp price holders
- 92 Price cassettes
- 98 Blackboards and chalk markers



# THE PRICERS THAT SELL

## DELI SERIES

Price holders with Pick&Mix concept – many parts in several colors that you can combine for multiple applications.



## PRICE CASSETTES

Gorgeous looking and universal price and product information communication tool. The price cassettes have become an integral part of nice looking supermarkets around the world.



## SWIVEL SERIES

Best selling series that is widely used around the world. Multiple combinations in 2 standard colors, ready to use sets and an opportunity to create a price holder right according to you need!



## UNIVERSAL PRICE HOLDERS

This group unites different price holders made from metal and plastic. You can see these holders not only in the supermarkets, but in bakeries, cafes, coffee shops.



### DELI PRICE HOLDERS – MOST COMMON COMBINATIONS

Below you can find the most common combinations of DELI price system components. Any combination can be bought in one of the 3 standard colors — transparent, white or black, other colors available on request.



#### DELI-FOT-SET DELI fot set with stick

+ DELI-STICK-SET is a combination of DELI series components (DELI-FOT-SET + DELI-STICK-SET) for holding price tags. Allows creating a row of price tags at the same height. Recommended to use with blackboard, laminated price tags or PET/PVC label holders. Standard colors: black, white and transparent.

Black board or label sleeve sold separately

Color: Tr Wh Sc  
Packaging: 20 pcs.

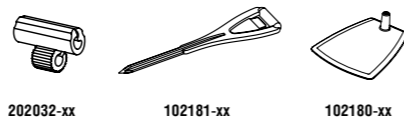

COLOR	BASE	CODE
White	✓	202178-01
Transparent	✓	202178-00
Black	✓	202178-10
White	-	202169-01
Transparent	-	202169-00
Black	-	202169-10



#### DELI-SIDE-SET40 DELI set with adapter (height 40 mm) for fixing on edge of dishes

DELI UNBO40 SET is a TOP Seller combination of DELI series components (DELI-CL, DELI-UNBO40, DELI-SH) for holding price tags on bowls with fresh made products. Recommended to use with blackboard, laminated price tags or PET/PVC label holders. Standard colors: black, white and transparent.

Black board or label sleeve sold separately

Color: Tr Wh Sc  
Packaging: 20 pcs.



COLOR	CODE
White	202267
Transparent	202266
Black	202268



#### DELI-SIDE-SET90 DELI set with adapter (height 90 mm) for fixing on edge of dishes

DELI UNBO90 SET is a combination of DELI series components (DELI-CL, DELI-UNBO90, DELI-SH) for holding price tags on bowls with fresh made products. The 90 mm height adapter allows you to use the price tags in the second row gastronomic containers. Recommended to use with blackboard, laminated price tags or PET/PVC label holders. Standard colors: black, white and transparent.

Black board or label sleeve sold separately

Color: Tr Wh Sc  
Packaging: 20 pcs.



CODE
202173-xx



#### DELI-UNBO-SET40 DELI price holder with adjustable incline angle

40 mm high DELI combination for holding price tags on bowls with fresh made products. The ratchet connectors allow to set the necessary price tag height and angle.

Black board or label sleeve sold separately

Color: Tr Wh Sc  
Packaging: 20 pcs.



CODE
202226-01



#### DELI-UNBO-SET90 DELI price holder with adjustable incline angle

DELI FOT UNBO90 SET is a combination of DELI-FOT-UNBO, DELI-UNBO90 and DELI-SH holder. The ratchet connectors allow to set the necessary price tag height and angle. Recommended to use with blackboard, laminated price tags or PET/PVC label holders. Standard colors: black, white and transparent.

Black board or label sleeve sold separately

Color: Tr Wh Sc  
Packaging: 20 pcs.



CODE
202170-xx



#### DELI-ICE-SET Price holders for ice

Combination with DELI-SH sign holder or DELI TECHNO joint for price holder with price tags or TECHNO MINI frames. To be stuck in ice.

Black board or label sleeve sold separately

Color: Wh Sc  
Packaging: 20 pcs.

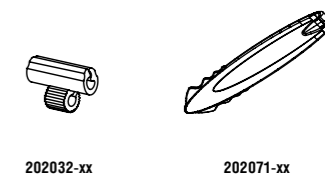

CODE
202172-xx



#### DELI-TECHNO-SIDE-SET40 40 DELI set with MINI frames

DELI UNBO40 MINI frame SET is a combination of DELI series components (DELI-CL, DELI-UNBO90, and MINI plastic frames with a special connector). The ratchet connectors allow to set the necessary price tag height and angle, the plastic frame gives perfect look and protection to the price tag. Holders standard colors: black, white and transparent. Frames colors – on request.

Color: Tr Wh Sc  
Packaging: 20 pcs.

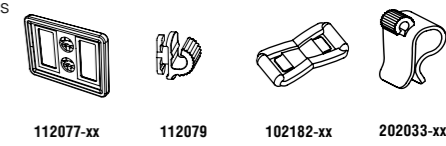

CODE
202176-xx

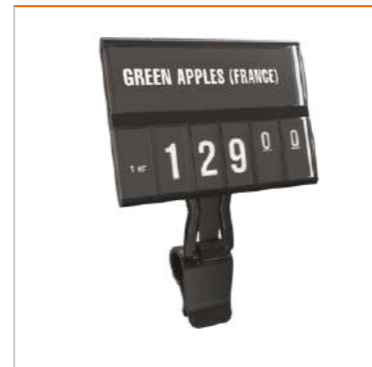

#### PC-DELI-SIDE-SET40 Price cassettes with a DELI holder

A set to be easily mounted on the salad bowl or a tray in DELI supermarket department.

Price cassette sold separately

Color: Tr Wh Sc  
Packaging: 20 pcs.

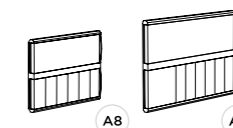

COLOR	CODE
White	222315
Black	222314
Transparent	222316



#### PC-DELI-UNBO-SET90 Price cassettes with base holder

This set can be put on any surface. The angle and the cassette height can be adjusted in 2 points, recommended to use with A8 or A7 price cassettes.

Price cassette sold separately

Color: Tr Wh Sc  
Packaging: 20 pcs.

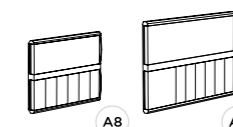
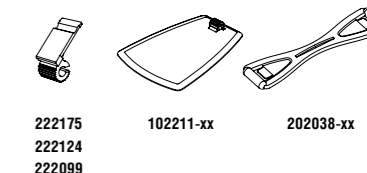

COLOR	CODE
White	222312
Transparent	222313
Black	222311



**DELI-SH** Sign holder

DELI series sign holder. Recommended to use with blackboards, laminated price tags or PET/PVC label holders. Best in combination with DELI-STICK, DELI-UNBO, DELI-STICK-ICE.

**Color:** Tr Wh Sc  
**Packaging:** 20 pcs.

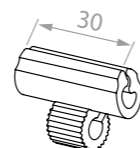

**CODE**  
**202032-xx**



**DELI-FOT-ST** Plastic base for DELI price holders

DELI series base component. Recommended to use with DELI-STICK and DELI-SH to create a DELI price holder with base.

**Color:** Tr Wh Sc  
**Packaging:** 20 pcs.

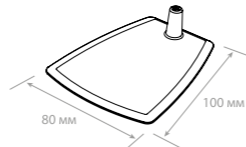

**CODE**  
**102180-xx**



**DELI-FOT-UNBO** Plastic base for FOT-UNBO joints

DELI series base component. Recommended to use with DELI-UNBO 40 or DELI-UNBO 90 and DELI-SH to create a DELI price holder with base. The ratchet connectors allow to set the necessary price tag height and angle.

**Color:** Tr Wh Sc  
**Packaging:** 20 pcs.

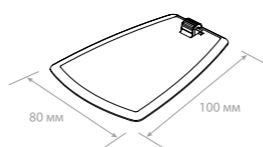

**CODE**  
**102211-xx**

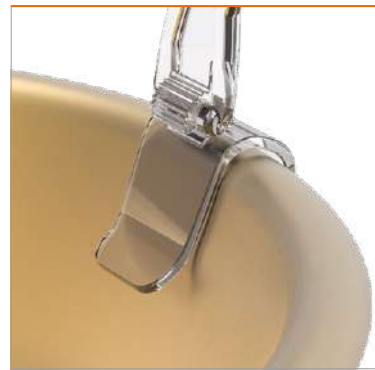

**DELI-CL** Plastic clamp

DELI series clip component. Recommended to use with DELI-UNBO and DELI-SH to create a price holder with adjustable incline angle on bowls up to 7 mm thick.

**Color:** Tr Wh Sc  
**Packaging:** 20 pcs.

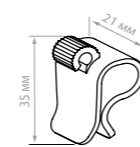

**CODE**  
**202033-xx**



**DELI-STICK** Plastic stick with sign holder

Plastic stick. Used with DELI-FOT-ST or pinned directly into the merchandise. Standard color: transparent, white, black.

**Color:** Tr Wh Sc  
**Packaging:** 20 pcs.

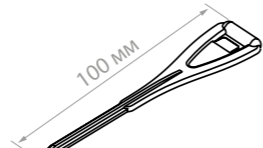

**CODE**  
**102181-xx**



**DELI-UNBO-40** Small swivel arm

DELI series clip component. Recommended to use as a joint with DELI-SH and DELI-FOT-UNBO or DELI-CL to create a price holder with adjustable height and incline angle.

**Color:** Tr Wh Sc  
**Packaging:** 20 pcs.

**CODE**  
**102182-xx**

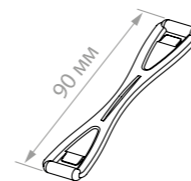
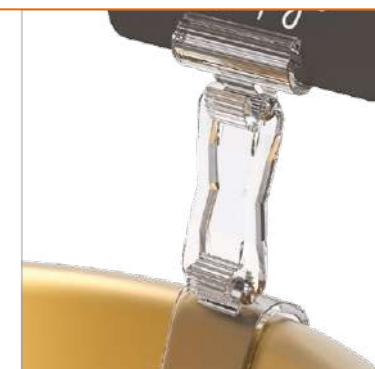

**DELI-UNBO-90** Large swivel arm

DELI series clip component. Recommended to use as a joint with DELI-SH and DELI-FOT-UNBO or DELI-CL to create a price holder with adjustable height and incline angle.

**Color:** Tr Wh Sc  
**Packaging:** 20 pcs.

**CODE**  
**202038-xx**



**DELI-STICK-ICE** Ice stick

DELI series stick component. Recommended to use with DELI-SH holders or DELI-TECHNO joints for price holders to be stuck in ice. Most commonly used in fresh fish department.

**Color:** Wh Sc  
**Packaging:** 20 pcs.

**CODE**  
**202071-xx**

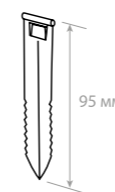
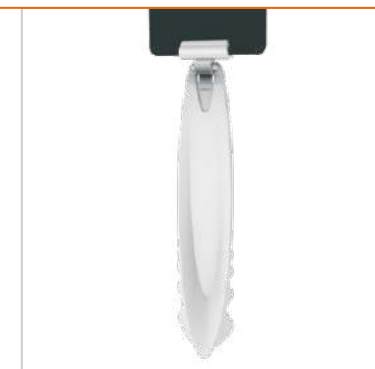

**DELI-MINISTICK-ICE** Small ice stick

Is used in combination with DELI-SH price holder on the ice pad of fish department.

**Color:** Tr  
**Packaging:** 20 pcs.

**CODE**  
**202282**

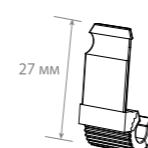

**DELI-ADAPTER-DELI** Adapter for price cassettes

DELI series connector. Recommended to use with DELI-UNBO or DELI-STICK to mount price cassettes or price holders with TAIL-ADAPTOR.

2 widths available - 9 and 11 mm. Standard colors: black, transparent

**Color:** Wh Sc  
**Packaging:** 20 pcs.

COLOR	CODE
White	222147
Black	222089



### SWIVEL PRICE HOLDERS

These price holders are widely spread in shops all around the world. They are universal to use in food and non-food shops, have multiple versions to fix it on different products and surfaces.



**FX** Universal price holder with big clamp

A universal price holder to be mounted on tubes, shelves, boxes. The pivoting card holder and a choice of long connectors gives maximum flexibility. Available in crystal clear and black colors.

**Color:** Tr Sc  
**Packaging:** 10 pcs.

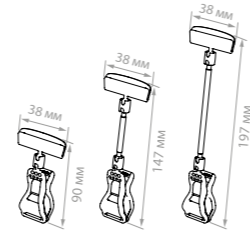

COLOR	SIZE	CODE
Transparent	0 / 50 / 100	202001 / 202002 / 202003
Black	0 / 50 / 100	202001-10 / 202002-10 / 202003-10



**FX-CLAMP-SLIM** Universal price holder with slim clamp and wide spring clip

A universal price holder with narrow clamp (55mm wide). Available in transparent and black colors.

**Color:** Tr Sc  
**Packaging:** 10 pcs.

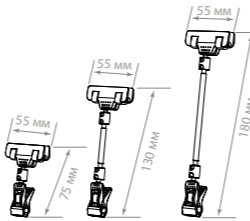

COLOR	SIZE	CODE
Transparent	0 / 50 / 100	202754 / 202756 / 202758
Black	0 / 50 / 100	202755 / 202757 / 202759



**FX-CLAMP** Universal price holder with big clamp and wide spring clip

A universal price holder to be mounted on tubes, shelves, boxes. The pivoting wide spring clip allows to hold thicker labels (e.g. blackboards). Available in crystal clear and black colors.

**Color:** Tr Sc  
**Packaging:** 10 pcs.

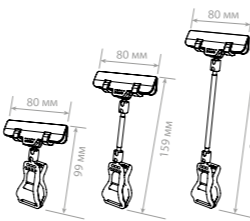

COLOR	SIZE	CODE
Transparent	0 / 50 / 100	202004 / 202040 / 202041
Black	0 / 50 / 100	202004-10 / 202040-10 / 202041-10



**FX-GRIP** Universal ratchet price holder

A universal price holder with ratchet to be mounted on tubes, shelves, boxes. Upper wide clip allows to hold thicker labels (e.g. blackboards). The ratchet mechanisms ensures high durability.

**Color:** Tr  
**Packaging:** 10 pcs.

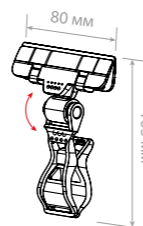

SPRING	CODE
Plastic	202210
Metal	202274

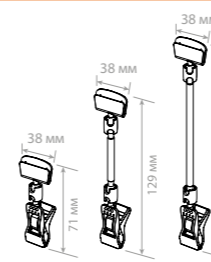

**FXS** Universal price holder with small clamp

A small size price holder to be fixed on shoes, boxes, product edge. Available in crystal clear and black colors.

**Color:** Tr Sc  
**Packaging:** 10 pcs.

COLOR	SIZE	CODE
Transparent	0 / 50 / 100	202005-00 / 202006 / 202007
Black	0 / 50 / 100	202005-10 / 202006-10 / 202007-10

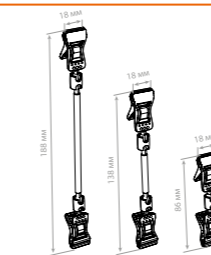

**FXS-DBL** Universal double clamp price holder

A small size price holder to be fixed on shoes, boxes, product edge. Available in crystal clear and black colors.

**Color:** Tr Sc  
**Packaging:** 10 pcs.

COLOR	SIZE	CODE
Transparent	0 / 50 / 100	202037 / 202106 / 202132
Black	0 / 50 / 100	202037-10 / 202106-10 / 202132-10

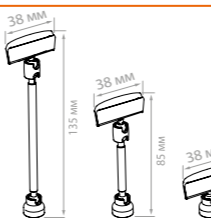

**MAG-CLIP** Magnetic pivoting card holder

Having a strong little magnet in its base, the holder provides flexibility in fixing a price tag or a sign on any metal surface. Available in crystal clear and black colors.

**Color:** Wh Sc  
**Packaging:** 10 pcs.

COLOR	SIZE	CODE
White	0 / 50 / 100 / 150	202045 / 202046 / 202047 / 202202
Black	0 / 50 / 100 / 150	202045-10 / 202046-10 / 202047-10 / 202202-10

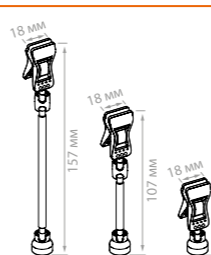

**MAG-FXS** Magnetic pivoting price holder

Having a strong little magnet in its base, the holder provides flexibility in fixing a price tag or a sign on any metal surface. Upper clip allows to hold thicker labels.

Available in crystal clear and black colors.

**Color:** Tr Sc  
**Packaging:** 10 pcs.

COLOR	SIZE	CODE
Transparent	0 / 50 / 100	202068 / 202069 / 202070
Black	0 / 50 / 100	202068-10 / 202069-10 / 202070-10

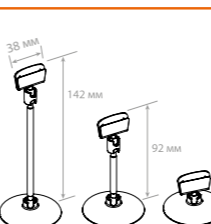

**BASE CLIP** Price holder with a round base

Price holder with a round base Ø 50mm. Available in crystal clear and black colors.

**Color:** Tr Sc  
**Packaging:** 10 pcs.

COLOR	SIZE	CODE
Transparent	0 / 50 / 100	202042 / 202043 / 202044
Black	0 / 50 / 100	202042-10 / 202043-10 / 202044-10





**FOT-FXS** Price holder with a plastic foot

Price holder with a plastic foot. The spade shape of the base allows to fix it under the product giving extra stability for the holder. Upper clip allows to hold thicker labels.

Available in crystal clear and black colors.

**Color:** Tr Sc  
**Packaging:** 10 pcs.

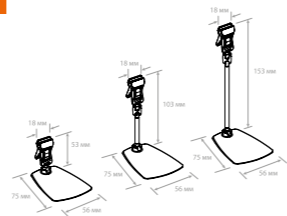

SIZE	CODE
0	202115-00
50	202116-00
100	202117-00



**BASE-XL-CLIP** Price holder with big round base

Price holder with a round base Ø 90mm. Big base provides extra stability, especially when used with long rods up to 200 mm.

Available in crystal clear and black colors.

**Color:** Tr  
**Packaging:** 10 pcs.

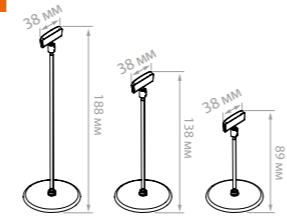

SIZE	CODE
100	202129
150	202208
200	202206



**BASE-ROD-T** Price holder with round base

This price holder is used in combination with the extruded price holders (VH series). You can combine different parts to create the holder of the necessary size and color.

2 height options available - 100, 150mm

**Color:** Tr  
**Packaging:** 10 pcs.

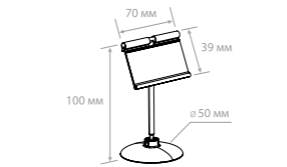

SIZE	CODE
100	202258
150	202294



**FOT-CLIP** Price holder with a plastic foot

Price holder with a plastic foot. The spade shape of the base allows to fix it under the product giving extra stability for the holder. Available in crystal clear and black colors.

**Color:** Tr Sc  
**Packaging:** 10 pcs.

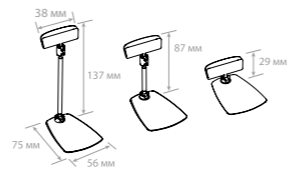

COLOR	SIZE	CODE
Transparent	0 / 50 / 100	202123 / 202124 / 202125
Black	0 / 50 / 100	202123-10 / 202124-10 / 202125-10



**CL-CLIP** Price holder with plastic clip

This price holder is designed to be fixed at the edge of the bowl and metal or plastic trays in Deli department. Pivotal connection of the parts allows easy angle change and price tag positioning.

**Clip color:** Wh  
**Packaging:** 10 pcs.

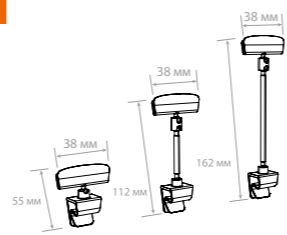

SIZE	CODE
0	202195
50	202196
100	202197



**CLIP-GRIP** Strong clip with wide clamp

This sturdy price holder is used when you need a stronger grip on the box with products. The wide clamp is universal for fixing any pricer up to 5 mm thick.

**Color:** Tr  
**Packaging:** 10 pcs.

CODE
202554



**RING-CLIP** Sausage price holder

Three different ring sizes let you the holder on nearly all available sausage shapes. The pivoting card holder gives flexibility with price tag presentation angle.

**Color grounds:** Wh  
**Color holder:** Tr  
**Packaging:** 10 pcs.

Ø, MM	CODE
35-65	112007
65-140	112008

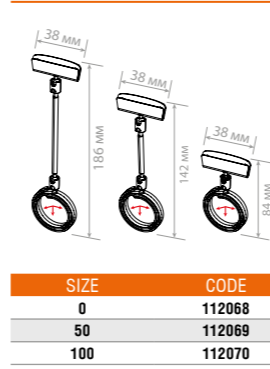

**ROLL-CLIP** Coil price holder for sausage

Universal coil price holder for sausage. One-size-fits-all can be mounted on any sausage 30 to 120 mm in diameter.

**Color:** Tr  
**Packaging:** 10 pcs.

SIZE	CODE
0	112068
50	112069
100	112070

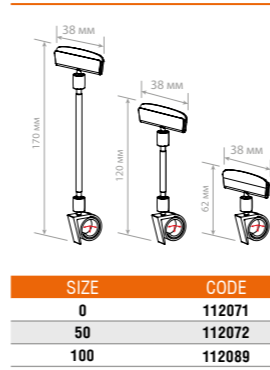

**ROLL-CLIP-L** Universal coil price holder

Universal coil price holder to be fixed on bowls, shelves or products. With adjustable incline angle.

**Color:** Tr  
**Packaging:** 10 pcs.

SIZE	CODE
0	112071
50	112072
100	112089

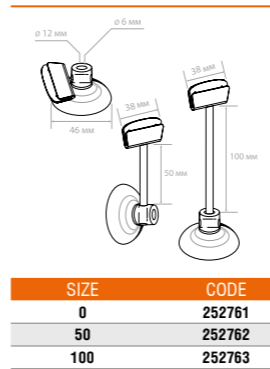

**SC-CLIP** Suction cup price holder

This price holder has a double suction cup to ensure strong grip. You can fix pricer with different angles using various combinations of this holder.

**Color:** Tr  
**Packaging:** 10 pcs.

SIZE	CODE
0	252761
50	252762
100	252763



**TENS OF COMPONENTS — HUNDREDS OF COMBINATIONS... IN AN EASY WAY!**

What makes our price holder components so unique — they are made from strong PC. This gives extra **STRENGTH** to the product and the **EASE** to assemble it from the little parts. Choose from the standard products on our stock or make a product of your own design — easy and in no time!

	ROD + JOINT	CARDHOLDER-38	CARDCLAMP-90	CARDCLAMP-55	CLIP LARGE	CLIP SMALL	TM A8	ROD-T	VH	PC-DIGIT-A8
ROUND BASE	0									
	50									
	100									
	150									
	200									
BASE-XL	0									
	50									
	100									
	150									
	200									
FOT	0									
	50									
	100									
	150									
	200									
MAG-BASE	0									
	50									
	100									
	150									
	200									
ROLL-VL	0									
	50									
	100									
	150									
	200									
ROLL-VL-L	0									
	50									
	100									
	150									
	200									
RING-CLIP	0									
	50									
	100									
	150									
	200									
CLIP LARGE	0									
	50									
	100									
	150									
	200									
CLIP SMALL	0									
	50									
	100									
	150									
	200									
CL	0									
	50									
	100									
	150									
	200									
STICK	0									
	50									
	100									
	150									
	200									
BOTTLE CAP	0									
	50									
	100									
	150									
	200									

recommended combinations

**COMPONENTS COMBINATION**



<b>1</b>	<b>CARDCLAMP-VL</b>	<b>CARDCLAMP-55</b>	<b>TM A7</b>	<b>PC-DIGIT-A8</b>
	<input type="radio"/> 202013 <input checked="" type="radio"/> 202013-10	<input type="radio"/> 202752 <input checked="" type="radio"/> 202753	<input type="radio"/> 112061	<input type="radio"/> 222100 / 222130 / 222139 / 222141 <input checked="" type="radio"/> 222140 / 222163
<b>2</b>	<b>CARDHOLDER-38</b>	<b>CLIP LARGE</b>	<b>CLIP SMALL</b>	<b>VH</b>
	<input type="radio"/> 202612 <input checked="" type="radio"/> 202670	<input type="radio"/> 202009 <input checked="" type="radio"/> 202009-10	<input type="radio"/> 202010 <input checked="" type="radio"/> 202010-10	<input type="radio"/> 195009 / 195065
<b>ROD-VL</b>	<b>JOINT-VL</b>	<b>ROD-T</b>	<b>3</b>	<b>ROLL-VL</b>
<input type="radio"/> 202017 - 202020 <input checked="" type="radio"/> 202017-10 - 202020-10	<input type="radio"/> 202008 <input checked="" type="radio"/> 202008-10	<input type="radio"/> 202243 / 202245 <input checked="" type="radio"/> 202244 / 202246		<input type="radio"/> 202300
<b>ROLL-VL-L</b>	<b>ROUND BASE-VL</b>	<b>BASE-XL</b>	<b>FOT</b>	<b>RING-CLIP</b>
<input type="radio"/> 202494	<input type="radio"/> 202014 <input checked="" type="radio"/> 202014-10	<input type="radio"/> 202295	<input type="radio"/> 202126 <input checked="" type="radio"/> 202126-10	<input type="radio"/> 112006 / 112014
<b>CLIP LARGE</b>	<b>CLIP SMALL</b>	<b>MAG-BASE-VL</b>	<b>CL</b>	<b>BOTTLE CAP</b>
<input type="radio"/> 202009 <input checked="" type="radio"/> 202009-10	<input type="radio"/> 202010 <input checked="" type="radio"/> 202010-10	<input type="radio"/> 202023 <input checked="" type="radio"/> 202023-10	<input type="radio"/> 202194	<input type="radio"/> 202241

### UNIVERSAL PRICE HOLDERS

We have a variety of universal price holders to support your price and product information in any type of retail outlet. Most of these holders are standard stock items, plastic holders can be produced in different colors.



**PRISM** Plastic price holder

Compact plastic price holder for pricer inserts up to 1mm thick. A simple to use solution for use in coffeeshops and bakeries.

**Color:** Tr

**Packaging:** 100 pcs.

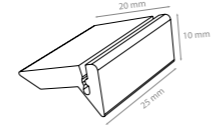

CODE	
202242	



**CARDFIX-75** Inclined price holder

A universal bestseller. With 2 color versions (transparent and black) and simplicity in use, this price holder can be met everywhere around the world – in supermarkets, cafes, bakeries, coffee shops.

**Color:** Tr Sc

**Packaging:** 10 pcs.

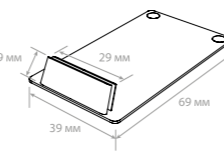

COLOR	CODE
Transparent	202273
Black	202288



**CARDFIX-90** Vertical plastic price holder

The vertical version of CARDFIX price holder. With 2 color versions (transparent and black) and simplicity in use, this price holder can be met everywhere around the world - in supermarkets, cafes, bakeries, coffee shops.

**Color:** Tr Sc

**Packaging:** 10 pcs.

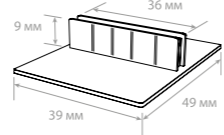

COLOR	CODE
Transparent	202257
Black	202292



**MIDICLIP** Clip-type price holder

A universal clip price holder. Can be easily mounted on a cup, bowl or a crate with products. The pricer can be attached looking up or down the clip.

Available in 2 colors - black and white.

**Color:** Wh Sc

**Packaging:** 10 pcs.

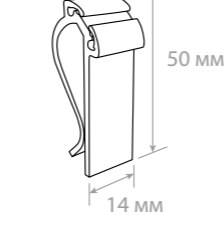

COLOR	CODE
White	202304
Black	202489



**MINISTICK** Universal stick price holder

A multi-purpose stick holder. Allows to put the price on any surface or stick it into product.

Available in 2 colors - black and white.

**Color:** Wh Sc

**Packaging:** 10 pcs.



COLOR	CODE
White	500952
Black	502859

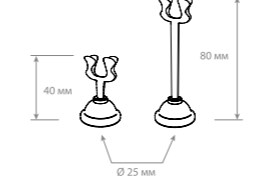

**MV-CLIP** Metal price holder

2 smaller metal price holders - 40 and 80 mm high. They are widely used in coffee shops and bakeries. The metal base makes the holder very stable.

**Color:** Sl

**Packaging:** 1 pcs.



COLOR	CODE
40	181005
80	181006

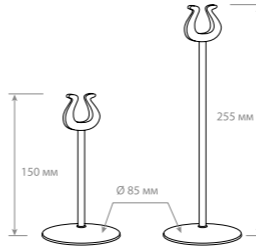

**MV-CLIP** Fenix shape metal price holder

Bigger versions of metal price holders - 150 and 235 mm high. They are used to hold bigger price boards, up to A6 or A5 size.

**Color:** Sl

**Packaging:** 1 pcs.



HEIGHT, MM	CODE
150	181010
255	181011

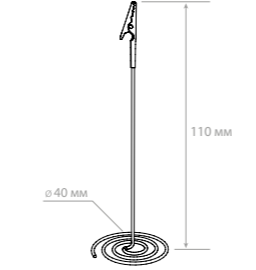

**SPIRAL-CLIP** Metal price holder with clamp and spiral base

This slim and nice looking metal price holder can hold pricers of different thickness thanks to its upper clamp. The spiral base keeps the product stable.

**Color:** Sl

**Packaging:** 10 pcs.



CODE
181004

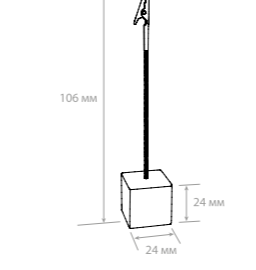

**CUBE-CLIP** Price holder with cube base

A commonly used price holder that can be used in cafes and non-food stores.

Can be supplied with cubes of different colors and materials.

**Color:** Sl Sc

**Packaging:** 10 pcs.



COLOR	CODE
Silver	181002
Black	181003

**BIG CLAMP PRICE HOLDERS**

The price holders of this type are widely used to communicate product information and special offer messages. They can hold signs as big as A5 and A4.



**CLAMP** Big universal clamp

Universal plastic clamp with 9mm rod can be used to create a variety of price and sign holders with plastic frames, PET or acrylic pockets or wide clamps.

Color: **Tr**  
Packaging: 10 pcs.

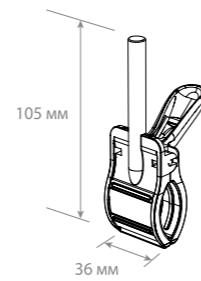

CODE  
102220



**CLAMP-DBL** Universal sign clamp holder

Easy to use sign holder to be fixed on crates, shelf edge or shop equipment rails with thickness up to 40mm. The upper clamp holds signs up to 6 mm thick.

Color: **Tr**  
Packaging: 10 pcs.

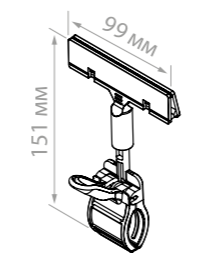

CODE  
102175-00

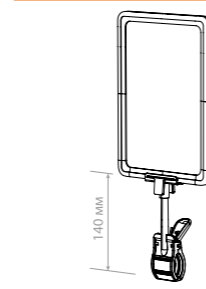

CODE  
102186-xx

**CLAMP-T** Plastic frame holder

A widely used clamp to create an efficient sign holder with A6, A5 or A4 plastic frames. The colored plastic frames create a standing out look that attracts shoppers.

Color: **Tr** **Sc**  
Packaging: 10 pcs.

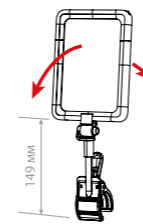

CODE  
102233

**CLAMP-T-SW** Plastic frame holder with angle adjustment

Similar to CLAMP-T sign holder with a ratchet to incline the sign for better information presentation to the customers.

Color: **Tr**  
Packaging: 10 pcs.

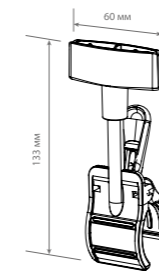

CODE  
102777

**CLAMP + SM-FIX** Universal sign holder

A more simple version on CLAMP-DBL to use with acrylic or foam PVC signs 2-3mm thick.

Color: **Tr**  
Packaging: 10 pcs.

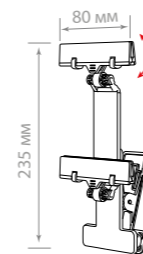

CODE  
222409

**V-CLAMP-GRIP** Double clamp holder

A great tool to organize pricing communication in Fruits & Vegetables Department. Two wide clamps allow to fix pricers of any size and thickness - including blackboards.

Color: **Sc**  
Packaging: 10 pcs.

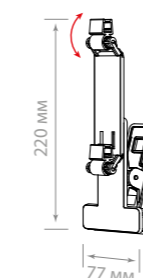

CODE  
222408

**V-CLAMP-PF** Double frame clamp holder

A great tool to organize pricing communication in Fruits & Vegetables Department. Recommended to use with two A6 frames, the frames color can be chosen from the standard range.

Color: **Sc**  
Packaging: 10 pcs.





# PRICE CASSETTES - EFFICIENT AND ELEGANT WAY TO COMMUNICATE PRICE AND PRODUCT INFORMATION



## Salads



## Cheese



## Fish



## Meat



## Fruits & Vegetables

## Bakery



**PRICE CASSETTES**

Price cassettes is whole generation of price labels that improves not only the quality of price presentation to shoppers, but the way the product information is communicated. They help to standardize the way the prices look and the messages you want to deliver to your customers.

**PRICE CASSETTES HOLDERS**

We have a large variety of Price Cassettes holders to be used in different parts of the store. You can hang them, fix on a bowl or a crate, set on the horizontal surface. You can also adjust the angle of the pricer to ensure it is seen best by the shoppers.



A8

**PC DIGIT-A8** A8 Price cassette

A small price cassette with 6 slots for digits or product information and wide insert for the product title. 2 separate blocks protect the paper inserts from water and humidity. Available in several colors.

**Price cassette color:** Re Wh Ye Gn Bl Sc  
**Notebook color:** Sc Wh  
**Package:** 20 pcs.



A7

**PC DIGIT-A7** A7 Price cassette

A medium size price cassette with 6 slots for digits, a square slot for additional information and wide insert for the product title. Available in several colors.

2 separate blocks protect the paper inserts from water and humidity. Available in several colors.

**Price cassette color:** Wh Gn Sc  
**Notebook color:** Sc Wh  
**Package:** 20 pcs.



A7+

**PC DIGIT-A7L** A7 Long price cassette

The wide price cassette with 7 slots for digits, a square slot for additional information and wide insert for the product title with a separate square window.

2 separate blocks protect the paper inserts from water and humidity. Available in several colors.

**Price cassette color:** Wh Gn Sc  
**Notebook color:** Sc Wh  
**Package:** 20 pcs.



**TAIL ADAPTER** Price cassette type back holde

This small connector can be attached on adhesive tape on the back of any pricer or a blackboard. Thus, it can be used with all existing price cassette holders.

Available in 2 colors: black and white

**Color:** Tr Sc  
**Packaging:** 20 pcs.

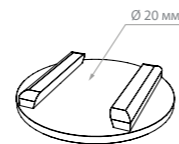

COLOR	CODE
Transparent	222361
Black	222360

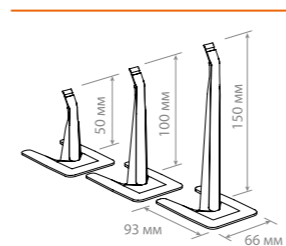

SIZE	CODE
50	222133
100	222134
150	222135

**PC-STAND** Price cassette stand

This plastic injected stand is a simple way to fix price cassettes in cooler area or on shelves. The stand has solid base, the cassettes connection is reliable and intuitively simple.

3 sizes available – 50, 100, 150mm.

**Color:** Tr  
**Package:** 10 pcs.

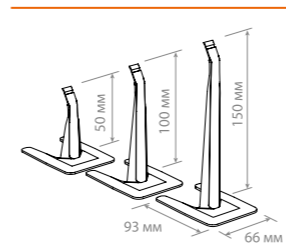
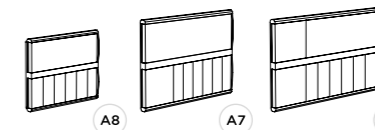

SIZE	CODE
50	222353
100	222354
150	222355

**PC-STAND** Price cassette stand

Black version of the PC-STAND. The black color is a perfect match for black, red and green cassettes.

3 sizes available – 50, 100, 150 mm

**Color:** Sc  
**Package:** 10 pcs.

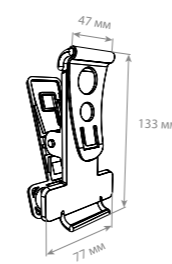
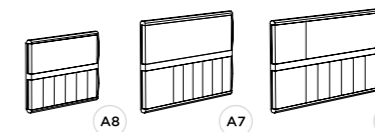

CODE
202540

**V-CLAMP** Big clamp for Fruits & Vegetables crates

The V-CLAMP is created to fix larger price cassettes (A7, A7 Long) on the Fruit&Veg crates and baskets. It is a robust tool that allows to fix 1 or 2 cassettes (at different levels) and keep them vertical to ensure perfect price communication to shoppers.

**Color:** Sc  
**Package:** 5 pcs.

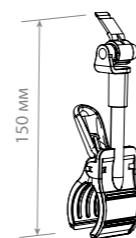
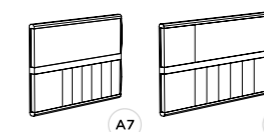

CODE
222307

**PC-CLAMP-T** Big clamp for Price cassettes

This holder is a sturdy tool to fix bigger size cassettes (A7, A7 Long) on on baskets, crates, rails.

**Color:** Tr  
**Package:** 10 pcs.

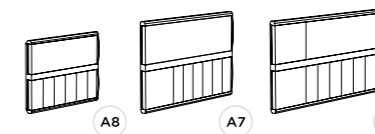



**PC-DELI-SIDE-SET40** DELI Price cassette holder

Price holder for the DELI bowls.  
Angle is adjusted in 2 points.  
Price cassette sold separately  
**Color:** Tr Wh Sc  
**Package:** 20 pcs.

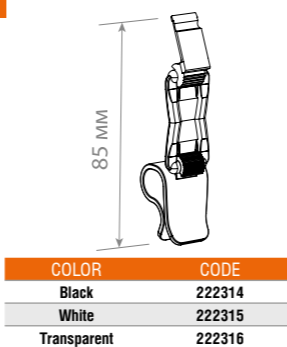
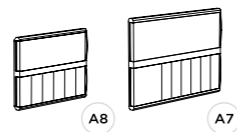

**PC-DELI-ICE-SET** Price cassette holder for ice pads

A special price cassette holder for ice bed in fish and seafood department.  
Available in black and white colors.  
Price cassette sold separately  
**Color:** Wh Sc  
**Package:** 20 pcs.

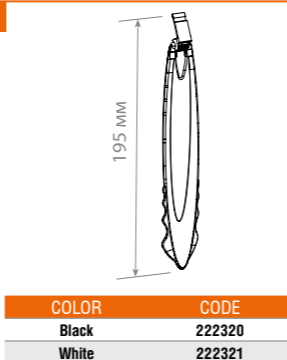
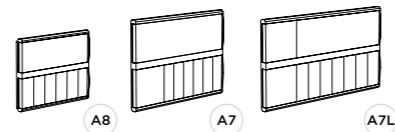

**PC-DELI-FOT-SET** Stick and foot holder for price cassette

This holder is a combination of DELI-FOT stand and PC-DELI-STICK-SET holder, thus is versatile to use in different situations.  
Price cassette sold separately  
**Color:** Tr Wh Sc  
**Package:** 10 pcs.

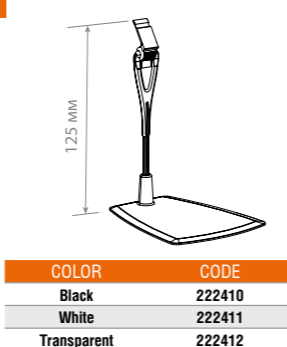
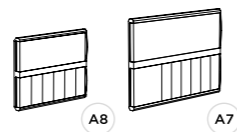

**PC-DELI-STICK-SET** Stick price cassette holder

A stick holder to mount price cassettes in salads, cheese and other products.  
Available in black, transparent and white colors.  
Price cassette sold separately  
**Color:** Tr Wh Sc  
**Package:** 20 pcs.

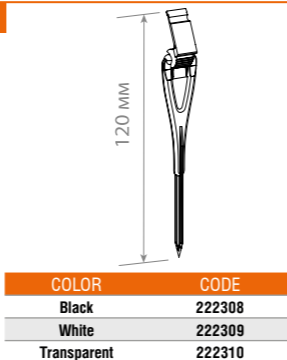
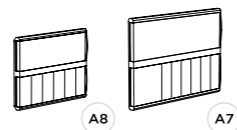

**PC-DELI-UNBO-SET90** Price cassette holder for flat surfaces

A holder with a flat stand to put the price cassettes on shelves in DELI departments, cafes and bakeries.  
Recommended to use with A8 or A7 cassettes.  
Price cassette sold separately  
**Color:** Tr Wh Sc  
**Package:** 20 pcs.

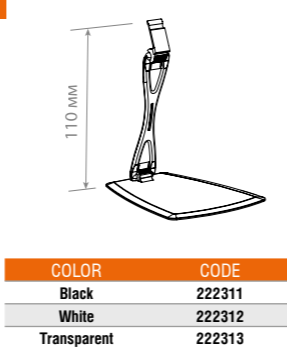
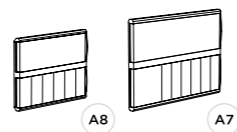

**PC-ROLL-CLIP** Price cassettes holder for sausages

The flexible grip of this holder allows to fix different sausage types - from 30 to 120mm in diameter.  
Recommended to use with A8 price cassettes.  
Price cassette sold separately  
**Color:** Wh  
**Package:** 10 pcs.

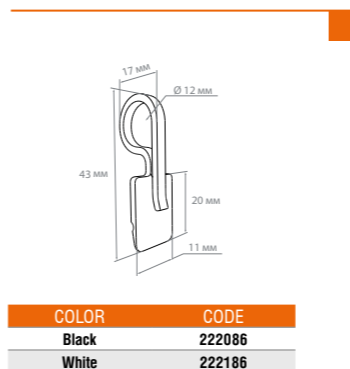

**PC HOOK** Hanging loop for price cassettes

This loop works for hanging the A7 and A7Long price cassettes on rails, as well as fixing them on the box or crate edge.  
Available in 2 colors - black and white.  
Recommended to use 2 loops for each price cassette.  
Price cassette sold separately  
**Color:** Wh Sc  
**Package:** 40 pcs.

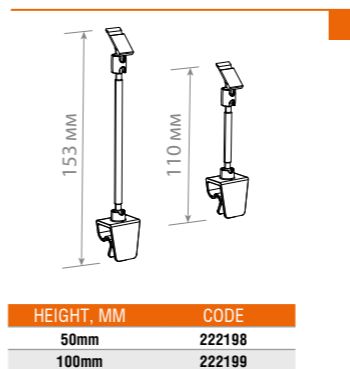
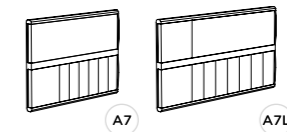

**PC-CL-CLIP** Bowl holder for price cassettes

This holder is perfect to mount price cassettes on a bowl or a tray in Deli department of supermarket.  
Recommended to use with A8 price cassettes.  
Price cassette sold separately  
**Color:** Wh  
**Package:** 10 pcs.

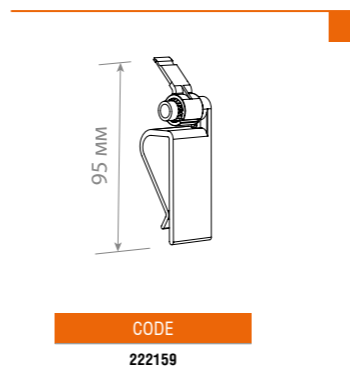

**PC-CLIP** Crate clip for price cassettes

Recommended for mounting on boxes, optimal for the «Vegetables and Fruits» department.  
Price cassette sold separately  
**Color:** Tr  
**Package:** 20 pcs.

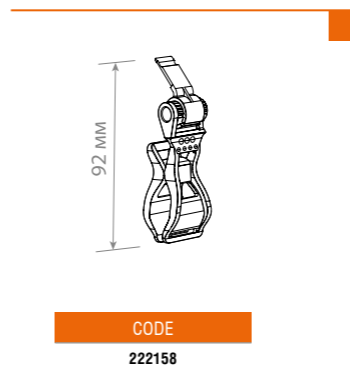
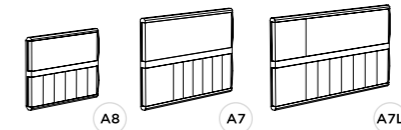

**PC-GRIP** Ratchet holder for price cassettes

This holder helps to mount price cassette on the bowl, crate or a basket. The sturdy structure of the holder holds all 3 sizes of price cassettes.  
Price cassette sold separately  
**Color:** Tr  
**Package:** 20 pcs.

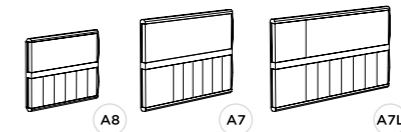

# BLACKBOARDS & CHALK MARKERS

With a variety of sizes, blackboard can be used all around supermarket, cafe or bakery with vivid, appealing messages



Thin blackboards can be used as inserts into the plastic or aluminum click-frames



You can use blackboards as part of the stands, using a wide variety of our stands components (see «Plastic frames» chapter for more details)



Blackboard can be used as inserts into plastic frames, hanging on the suspension rails



Small size blackboards are widely used as prices in combination with price holders (see the range of our price holders in our catalogue)

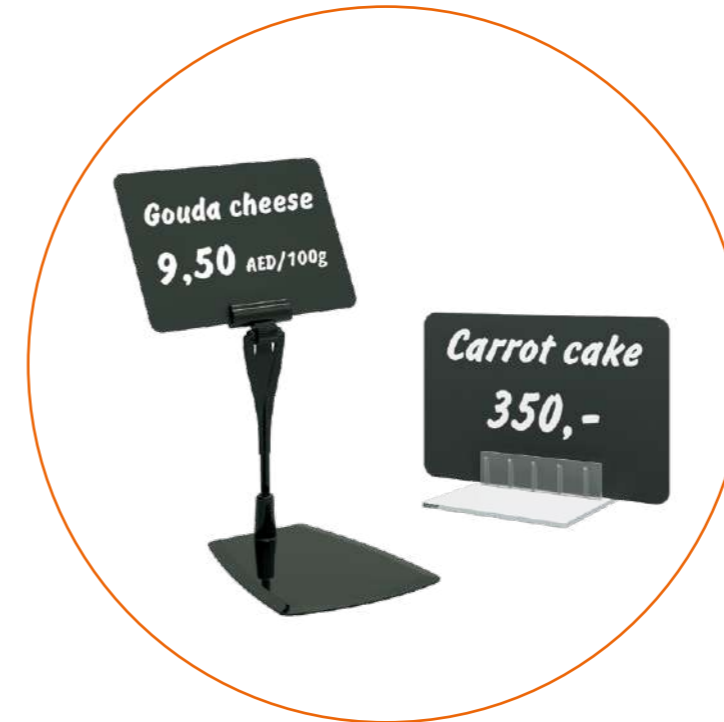

We have a range of special shaped blackboards to create attractive signs in meat, poultry and fish departments.



**SMALLER CHALKBOARDS: A8, A7, A6**

Chalkboards from special black plastic is a perfect sign base for smaller pricers. You can choose from a variety of our chalk markers to create pricers that stand out.

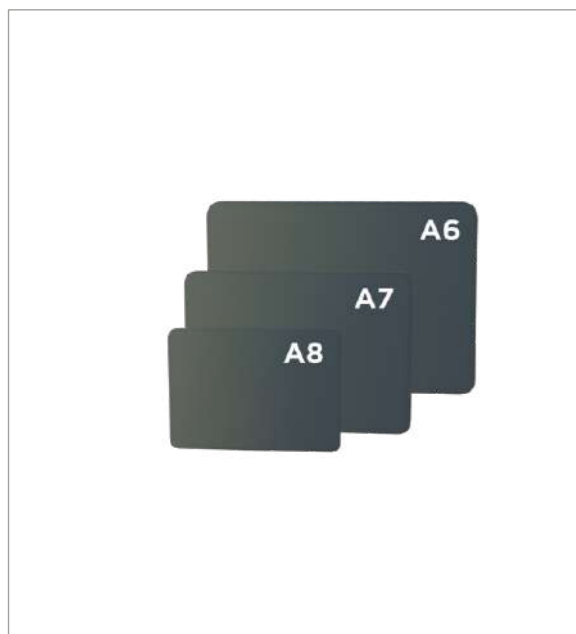

SIZE	CODE
A6	101043
A7	101044
A8	101045

**CHALKBOARDS : A5, A4, A3, A2, A1**

Bigger size chalkboards from special black plastic are recommended to use as inserts into plastic frames. For bigger signs we recommend to use chalkmarkers with a wider line option.

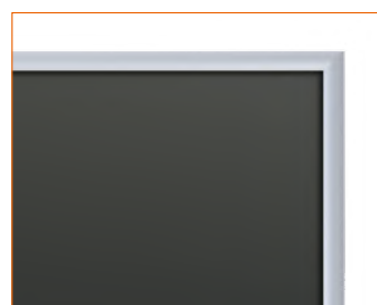

SIZE	CODE
A1	101038
A2	101039
A3	101040
A4	101040
A5	101042

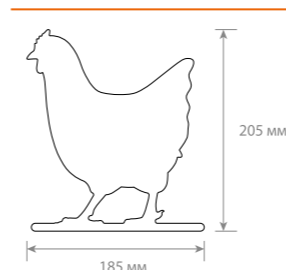

**BB CHICKEN | Chicken shaped blackboard**

Thick hen shaped blackboard with a wooden stand. Use CRETA chalk markers to create attractive pricer for chicken products.

**Color:** Sc  
**Package:** 1 pcs.

**CODE**  
204113

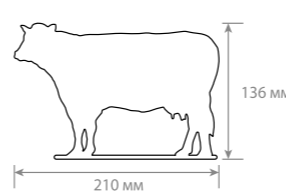

**BB COW | Cow shaped blackboard**

Thick cow shaped blackboard with a wooden stand. Use CRETA chalk markers to create attractive pricer for beef.

**Color:** Sc  
**Package:** 1 pcs.

**CODE**  
202521

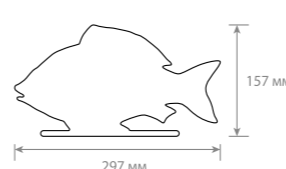

**BB FISH | Fish shaped blackboard**

Thick fish shaped blackboard with a wooden stand. Use CRETA chalk markers to create attractive pricer for fish.

**Color:** Sc  
**Package:** 1 pcs.

**CODE**  
204112

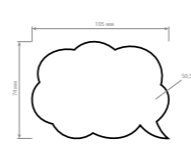

**CLOUD | Cloud shaped blackboard**

Thin blackboards to use with a standard price holder range to create unusual pricers with the help of CRETA chalk markers.

Material thickness – 0,65 mm

**Color:** Sc  
**Package:** 1 set contains 20 pcs + white CRETA marker.

**CODE**  
202372

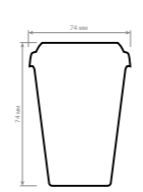
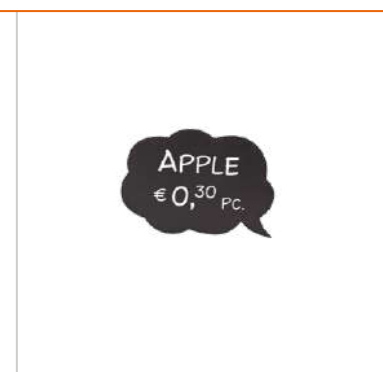

**COFFEE CUPS | Coffee cup shaped blackboard**

Thin coffee cup blackboards to be used with standard price holders to create attractive pricers in coffee shops.

Material thickness – 0,65 mm.

**Color:** Sc  
**Package:** 1 set contains 20 pcs + white CRETA marker.

**CODE**  
202373



**CRETA 1-3 CHALK MARKERS**

Water based chalk markers CRETA with 1-3 mm line thickness. Easy to write and wipe off the writing with a wet cloth. Recommended to use indoors. Different colors available. .



COLOR	CODE
	102381
	102341
	102342
	102344
	102345
	102346

**CRETA 10 CHALK MARKERS**

Water based chalk markers CRETA for bigger signs – the line width is 10 mm . Easy to write and wipe off the writing with a wet cloth. Recommended to use indoors. Different colors available.



COLOR	CODE
	102396
	102397
	102399

**CRETA 5 CHALK MARKERS**

Water based chalk markers CRETA with 5 mm line thickness. Easy to write and wipe off the writing with a wet cloth. Recommended to use indoors. Different colors available.



COLOR	CODE
	102423
	102424
	102425
	102426
	102427
	102428

**CRETA GLITTER 2-3 CHALK MARKERS**

A special series of CRETA chalk markers to create metallic look lines and writings. The line thickness is 2-3 mm. It is easy to write and wipe the written with a wet cloth. 3 colors available: golden, silver, purple.



COLOR	CODE
	102430
	102431
	102432

## 5

## INFORMATION HOLDERS



- 106 L-shaped pricer holders
- 108 Menu/sign holders
- 110 ACR-HOLDER sign holding system
- 112 Poster sleeves for suspension
- 114 Adhesive and magnetic poster sleeves
- 115 Rigid poster sleeves
- 116 Soft poster sleeves
- 117 Adhesive poster sleeves

**ACR-PRICER L-SHAPED PRICE HOLDERS**

Made from thick transparent acrylic glass, these holders are commonly used to present price and products information. Our range includes several standard stock sizes and products made on request.

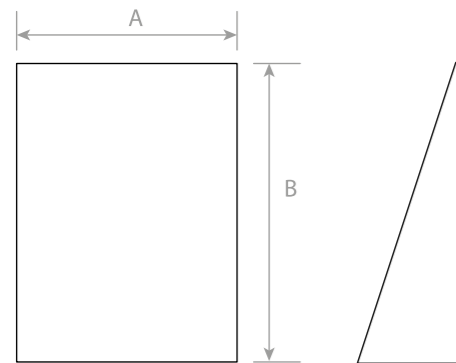
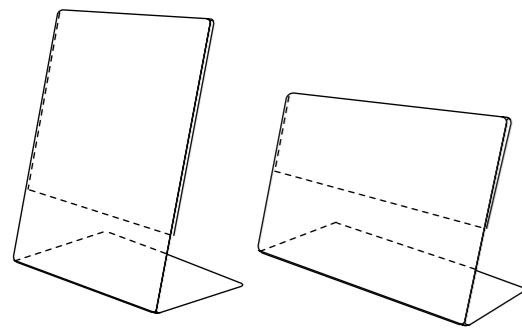

PRODUCT CODE	SIZE	DIMENSIONS: A-B (mm)
<b>VERTICAL</b>		
171003	A4	210 x 297
171002	A5	148 x 210
171001	A6	105 x 148
171005	A7	74 x 105
<b>HORIZONTAL</b>		
171009	A4	297 x 210
171008	A5	210 x 148
171007	A6	148 x 105

Other sizes - on request.

Color:   
 Packaging: 10pcs

**P-PRICER L-SHAPED PRICE HOLDERS FROM THIN PLASTIC**

These price and info holders are made from thin plastic. They are less fragile compared to acrylic holders, but more lightweight.

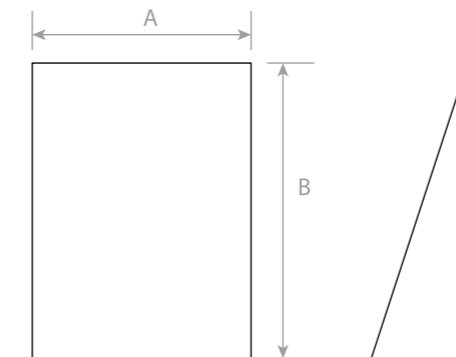
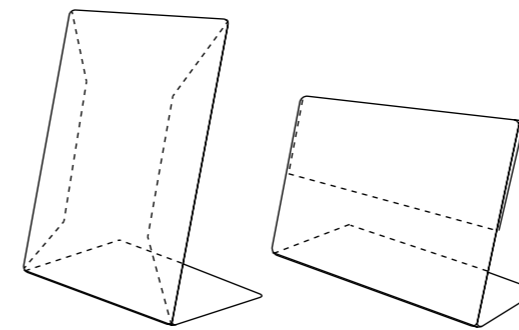

PRODUCT CODE	SIZE A-B (mm)
<b>VERTICAL</b>	
171870	210 x 297 (A4)
171871	148 x 210 (A5)
171904	105 x 148 (A6)
<b>HORIZONTAL</b>	
171872	40 x 30
171873	60 x 40
171874	70 x 50
171875	70 x 30
171876	80 x 60
171877	90 x 70
171878	100 x 40
171879	148 x 105
171880	105 x 75

Other sizes - on request.

Color:   
 Packaging: 10, 50, 100 pcs



### SIGN HOLDER WITH UPPER LOADING

This sign holder has a slot in the upper part for sign and poster loading. The holder has stable triangular base, the display part is double sided. This holder is a very efficient tool to present information in shops, showrooms and other points of sale.

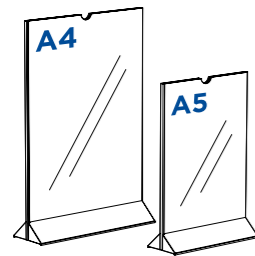
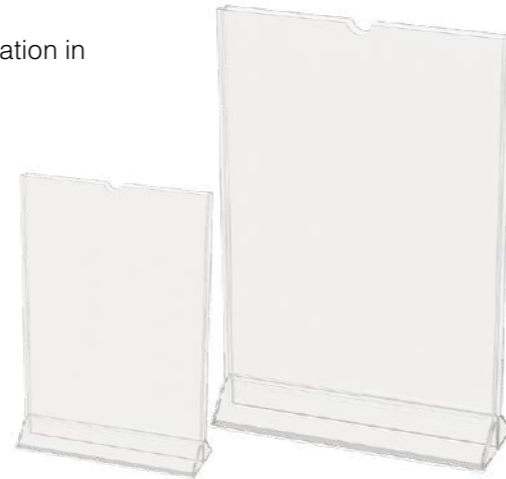

Two sizes available - A4 and A5, other sizes on request. Portrait (vertical) layout.

Color: Tr  
Packaging: 10pcs

PRODUCT CODE	SIZE
172219	A4
172218	A5

### METAL BASE SIGN HOLDER

These sign holders have a base from aluminium profile. The acrylic or PET poster sleeve is fixed on the base and can be easily taken off for sign change.

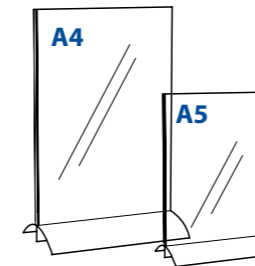
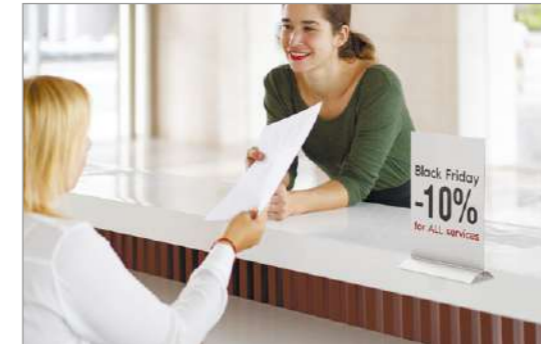

Three sizes available - A4,A5, A6. Other sizes on request. Portrait (vertical) layout.

Color: Tr  
Packaging: 10pcs

PRODUCT CODE	SIZE
172602	A4
172601	A5

### COLOR BASE MENU HOLDER

This sign holder has 2 separate parts : the base is injected and available in different colors. The sign sleeve is made from 1,5mm acrylic glass or PET. There is an option to put a blackboard ( for chalk marker writing) instead of the poster sleeve.

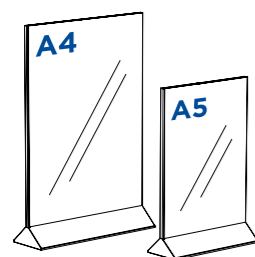

Two sizes available - A4 and A5, other sizes on request. Portrait (vertical) layout.

Color: Tr Re Sc  
Packaging: 1 pcs

BASE COLOR	SIZE	PRODUCT CODE
Black	A5	172590
Red	A5	172591
Black	A4	172592
Red	A4	172593

### WOODEN BASE MENU HOLDER

These sign holders have a base from wood. The acrylic or PET poster sleeve is fixed on the base and can be easily taken off for sign change.

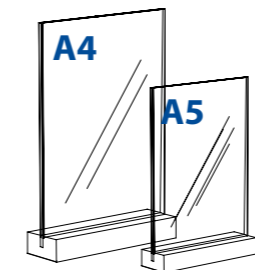

Three sizes available - A4,A5, A6. Other sizes on request. Portrait (vertical) layout.

Color: Tr  
Packaging: 10pcs

PRODUCT CODE	SIZE
172600	A4
172599	A5

**ACR-HOLDER - A SIMPLE WAY TO CATCH SHOPPERS ATTENTION**

ACR-HOLDER series is a set of components that you can use to create attractive signs and pricers. You can mix them to hold signs of different size and fix them on different surfaces and shop equipment.



**ACR-HOLDER 210 Acrylic sleeve holder**

Holds acrylic (or PET) poster sleeves or carton posters.  
Recommended insert thickness - 3mm.  
Insert width - 210mm.  
Fixed upon a 9mm tube or rod.

**Color:** Tr  
**Packaging:** 10 pcs.

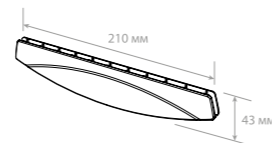
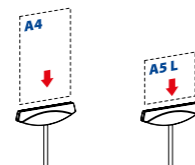

**PRODUCT CODE**  
**102210**

**ACR-HOLDER 150 Acrylic sleeve holder**

Holds acrylic (or PET) poster sleeves or carton posters.  
Recommended insert thickness - 3mm.  
Insert width - 150mm.  
Fixed upon a 9mm tube or rod.

**Color:** Tr  
**Packaging:** 10 pcs.

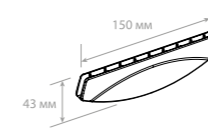

**PRODUCT CODE**  
**102209**

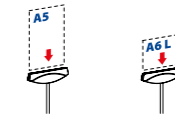

**ACR-PP A4 Acrylic sleeve, A4 vertical**

A4 (portrait) acrylic poster sleeve. Made from 1,5mm thick acrylic glass.  
Fits ACR-HOLDER and some MENU-HOLDER stands.

**Color:** Tr  
**Packaging:** 10 pcs.

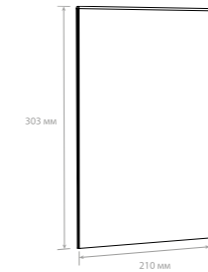

**PRODUCT CODE**  
**101036-1.5**



**ACR-PP A5 Acrylic sleeve, A5 vertical**

A5 (portrait) acrylic poster sleeve. Made from 1,5mm thick acrylic glass.  
Fits ACR-HOLDER and some MENU-HOLDER stands.

**Color:** Tr  
**Packaging:** 10 pcs.



**PRODUCT CODE**  
**101034-1.5**



**ACR-PP A5 Acrylic sleeve, A5 horizontal**

A5 (landscape) acrylic poster sleeve. Made from 1,5mm thick acrylic glass.  
Fits ACR-HOLDER and some MENU-HOLDER stands.

**Color:** Tr  
**Packaging:** 10 pcs.

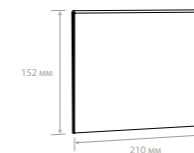

**PRODUCT CODE**  
**101328**



**ACR-PP A6 Acrylic sleeve, A46 horizontal**

A6 (landscape) acrylic poster sleeve. Made from 1,5mm thick acrylic glass.  
Fits ACR-HOLDER and some MENU-HOLDER stands.

**Color:** Tr  
**Packaging:** 10 pcs.

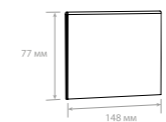

**PRODUCT CODE**  
**101329**



### PH POSTER SLEEVES

Made from thin transparent plastic, poster sleeves is a simple to use tool to hang posters in retail environment. We have different types of sleeves to fit the suspension mode.

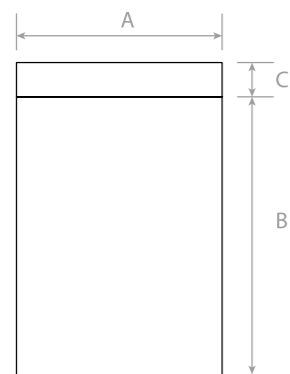
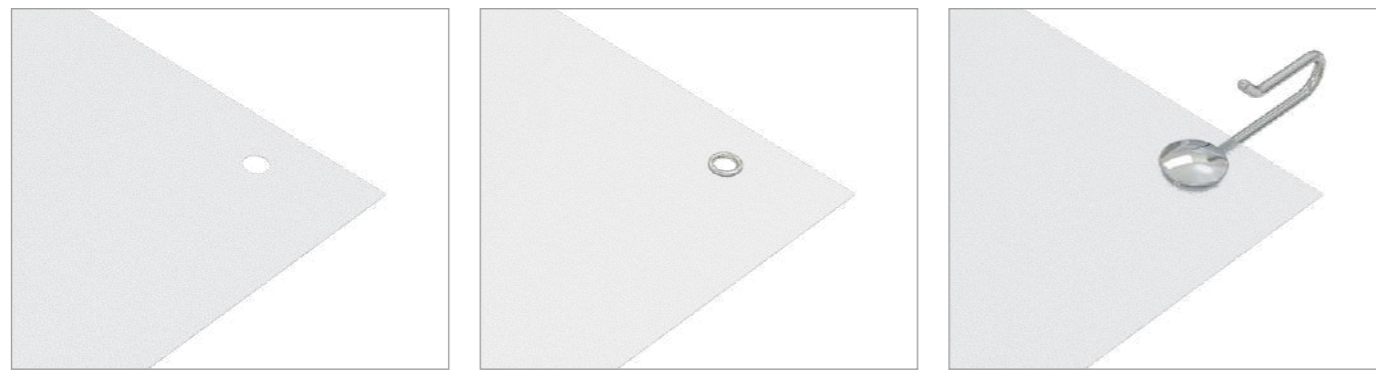

PRODUCT CODE	SIZE	A x B / C (mm)
171056-xx	A4	210 x 297 / 33
171057-xx	A3	297 x 420 / 30
171058-xx	A2	420 x 594 / 30
171059-xx	A1	594 x 840 / 31

### POSTER SLEEVES WITH METAL EYELETS

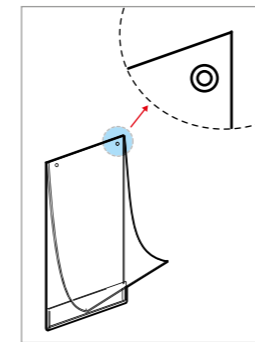

For bigger sleeves it is recommended to use metal eyelets in the suspension holes. The sleeves of this type usually have the opening in the bottom, thus making it easy to change posters not taking the sleeve down from the rail. Check for the sizes available.

Color:  Tr  
Packaging: 10 pcs.

### POSTER SLEEVES WITH HOLES

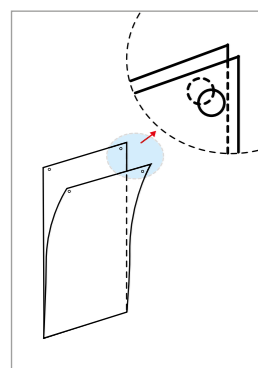

For sleeves up to A4 size metal eyelets are not obligatory since the poster weight is not big. Make a request to check standard sizes available.

Color:  Tr  
Packaging: 10 pcs.

### POSTER SLEEVES WITH HOOKS

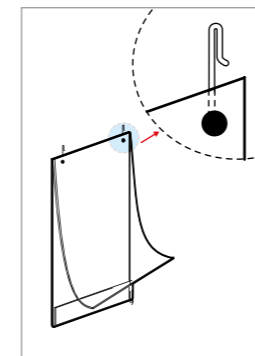

The sleeves with hooks are similar to the eyelet ones. The only difference are 2 integrated metal hooks fixed with a rivet. You can hang these sleeves directly on the aluminum profile with perforated rail. Check with us the available sizes.

Color:  Tr  
Packaging: 10 pcs.

### SLEEVES WITH ADHESIVE OR MAGNETIC STRIPS

This type of sleeves is widely used to place announcements and other information on any flat surface. Applicable to retail and office use.



#### PS-T PLASTIC SLEEVES WITH ADHESIVE TAPE

Plastic poster sleeve with bends in the upper and lower parts. Made of thin transparent plastic, has 2 adhesive strips to fix the sleeve on any flat surface.

Color:   
 Packaging: 10 pcs.

SIZE (PORTRAIT)	PRODUCT CODE
A6	171885
A5	171886
A4	171887
A3	171888

SIZE (LANDSCAPE)	PRODUCT CODE
A6	171881
A5	171882
A4	171883
A3	171884

### RIGID PLASTIC SLEEVES FOR SUSPENDED POSTERS

Made from thicker transparent plastic, these sleeves are designed for posters and signs suspension. They already have integrated holes, the sleeve is sealed from 3 sides.

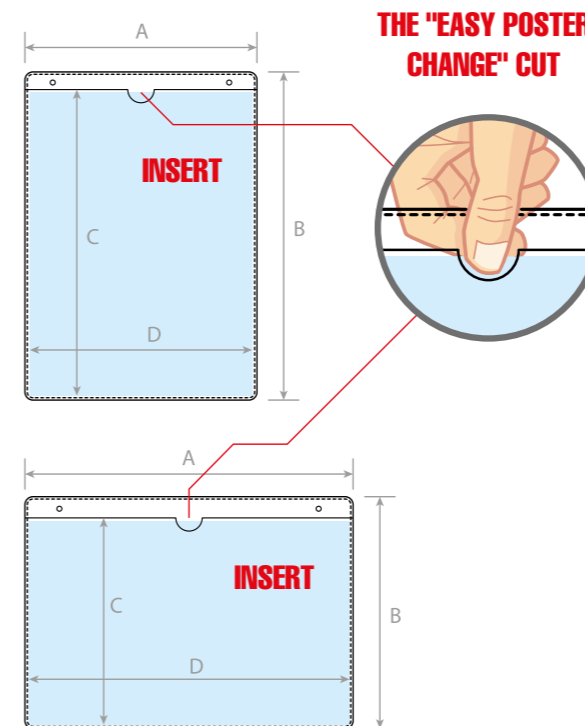

Color:   
 Packaging: 50 pcs.

SIZE (LANDSCAPE)	PRODUCT CODE	SIZE (LANDSCAPE)	PRODUCT CODE
A4	172257	A4	172256
A5	172322	A5	172341
A6	172250	A6	172251
A7	172273	A7	172255

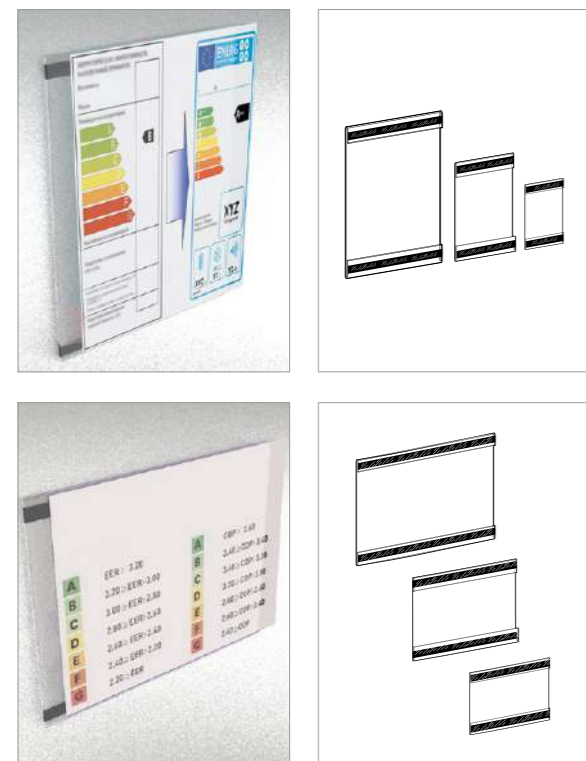

#### PS-M PLASTIC SLEEVES WITH MAGNETIC TAPE

Plastic poster sleeve with bends in the upper and lower parts designed for fixing on metal surfaces. Made of thin transparent plastic, has 2 magnetic strips to fix the sleeve on any flat surface.

Color:   
 Packaging: 10 pcs.

SIZE (LANDSCAPE)	PRODUCT CODE
A6	171889
A5	171890

SIZE (PORTRAIT)	PRODUCT CODE
A6	171892
A5	171893
A4	171894

**SOFT PRICER SLEEVES FW**

These pricer sleeves are made from soft transparent plastic. They are usually used as hang-on pricers on information holders, very often in furniture and DIY stores. Our range includes single and multi-pocket sleeves.



SINGLE SECTION PRICER SLEEVE		
SIZE	P/L	PRODUCT CODE
A4	Portrait	171061
A5	Portrait	171062
A6	Portrait	171063
A7	Portrait	171064
A8	Portrait	171065
A5	Landscape	172095
A6	Landscape	172096

MULTI-SECTION PRICER SLEEVE		
SIZE	NUMBER OF SECTIONS	PRODUCT CODE
116x55	2	172307
55x140	3	171208
209x113	3	171105
109x240	3	172046

\* - other sizes on request

**ADHESIVE SOFT PRICER SLEEVES FW-ADT**

These pricer sleeves have adhesive layer from one side, so they can be fixed on a flat clean surface (box, glass etc) as a pricer or poster holder.

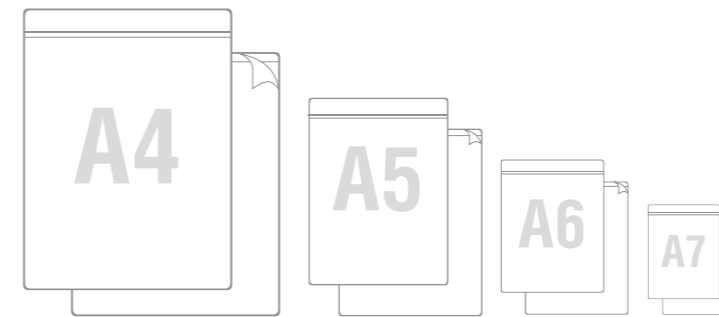

SIZE	PRODUCT CODE
A7	171514
A6	171136
A5	171137
A4	172868

**HOW TO CHOOSE PRICER SLEEVES ?**

- 1 Decide on the section quantity and fixing type (adhesive or hanging)
- 2 Check the paper insert (pricer) size
- 3 Choose the sleeve fitting your needs best
- 4 Talk to our managers if you have not found the pricer sleeve fitting your needs

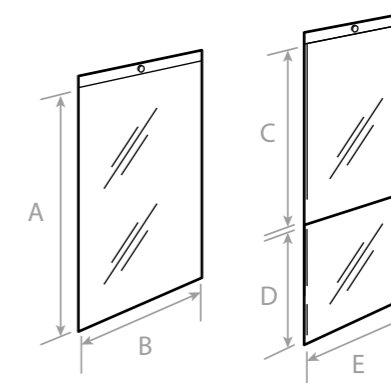
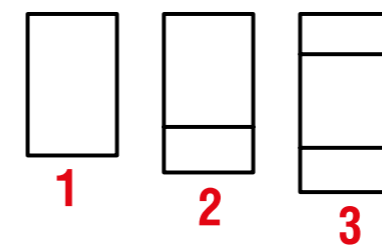
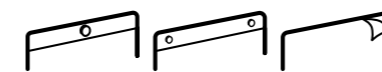

## 6 DISPLAY ACCESSORIES

- 120 Supergrip holders
- 121 Screws, rivets, clips
- 124 Suction cups
- 125 Suspension accessories
- 131 Plastic hooks
- 135 Display construction accessories



### HOLDERS WITH FLEXIBLE GRIP SUPERGRIP

SUPERGRIPs are widely used to create advertising constructions and to fix signs and shelftalkers. You can choose from wide range of grippers on our stock.

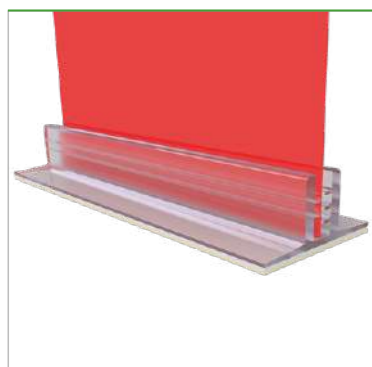

**SGT-25** Adhesive T-gripper

Adhesive T-gripper, 25 mm base.  
Length: 25 mm, 75 mm.  
Holds signs 0.5 – 3 mm thick.  
Color: **Tr**  
Packaging: 100 pcs.

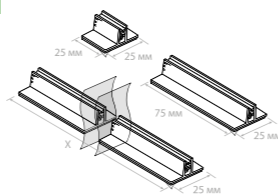

LENGTH, MM	CODE
25	251018
75	251019

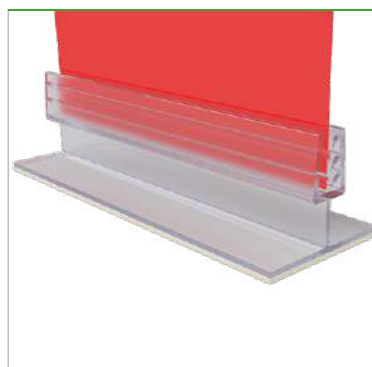

**SGT-FLEX** Adhesive L-gripper

T-gripper with adhesive base with flexible connection for «swinging» function.  
Length: 25 mm, 75 mm.  
Holds signs 0.5 – 3 mm thick.  
Color: **Tr**  
Packaging: 100 pcs.

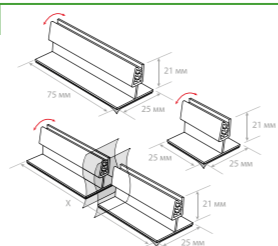

LENGTH, MM	CODE
25	254018
75	254019



**SGT-40** Large SUPERGRIP sign holder

SUPERGRIP sign holder for signs 0,5 to 6,0 mm thick. The sign has foamed adhesive tape on the base.  
Base width – 40 mm.  
Standard length – 75 mm, other lengths – on request.  
Color: **Tr**  
Packaging: 100 pcs.

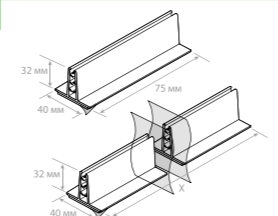

LENGTH, MM	CODE
75	252053
600	252061
1200	252062



**SGJ** Parallel SUPERGRIP sign holder

This holder is used to fix signs 1 to 3,0 mm thick parallel to the surface.  
Two standard length options – 25 and 75 mm.  
Color: **Tr**  
Packaging: 100 pcs.

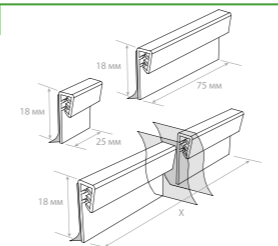

LENGTH, MM	CODE
25	254020
75	254021

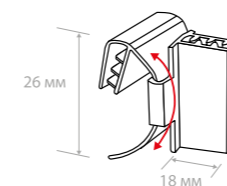

**SGKLG** Flag sign holder with adjustable angle

Flag sign holder with adjustable angle. To be fixed on the front panel of a datastrip.  
Color: **Tr**  
Packaging: 100 pcs.

CODE  
254022

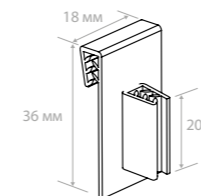
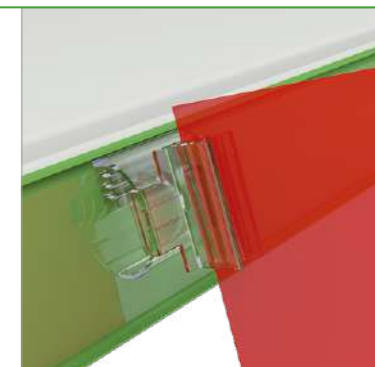

**SGKLG-00** Flag position sign holder

Fixed on the price strip edge, it can hold signs and shelftalkers 0,5 to 3,0 mm thick.  
Color: **Tr**  
Packaging: 100 pcs.

CODE  
254054

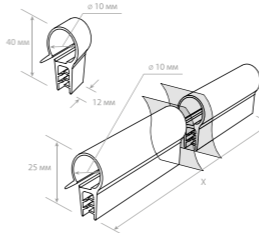

**SGW** Gripper wire holder

With gripper fins firmly holding signs 0,5 to 3,0 mm thick, it can hold signs in flush position on wire baskets, tubes, edging. Recommended to use minimum 2 holders for 1 sign.  
For wires up to 10 mm in diameter, standard length – 12 mm.  
Color: **Tr**  
Packaging: 100 pcs.

LENGTH, MM	CODE
12	252023
by request	–



### SCREWS, RIVETS, CLIPS

Our catalogues presents a verity of screws, rivets and clips to construct plastic, cardboard or light metal displays. Please, use our sample boxes to find the best fixing solution for your task.

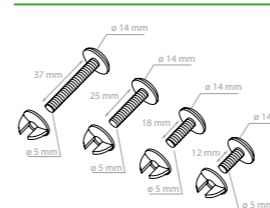

**VIKING SCREW** Plastic screw

Plastic screws with a V-shaped nut for easy tightening. Available in 4 lengths - 12, 18, 25 and 37 mm.  
Color: **Tr Sc**  
Packaging: 100 pcs.

SIZE x, MM	COLOR	CODE
12	Transparent / Black	254031-xx
18	Transparent / Black	254030-xx
25	Transparent / Black	254032-xx
37	Transparent	254553



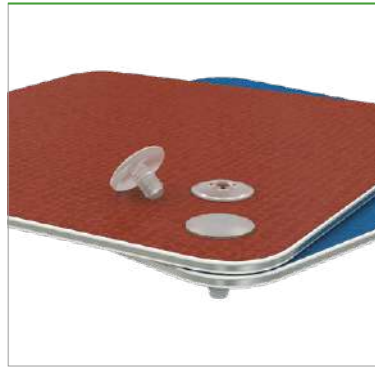

**QUICK LOCK** Plastic rivet

Plastic rivet, used to connect paper, cardboard or plastic parts. Available lengths - 8, 16mm

**Color:** Wh Sc  
**Packaging:** 100 pcs.

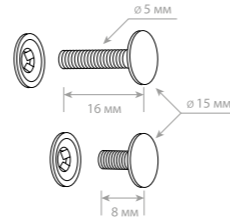

LENGTH, MM	CODE
8	254077-xx
16	254078-xx

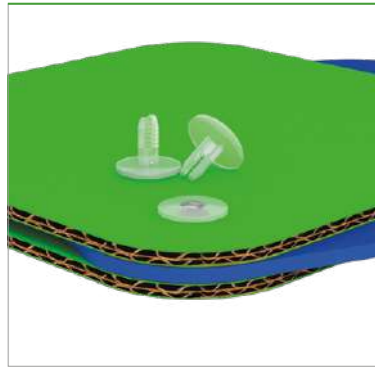

**UNI RIVET** Ratchet rivet fastener

This fastener consist of 2 parts, connected with each other by pressing the pieces together.

Head diameter - 15 mm  
Length - 6 and 11 mm

**Color:** Wh  
**Packaging:** 100 pcs.

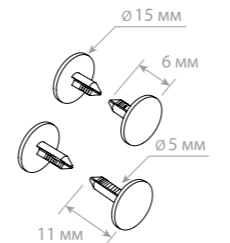

LENGTH, MM	CODE
6	254084-01
11	254088-01



**LARGE SNAP** Big snap fastener

This fastener is used to connect large components. With a wide 29 mm cap it creates secure fixing of carton and plastic display parts.

Length - 38 mm

**Color:** Wh  
**Packaging:** 100 pcs.

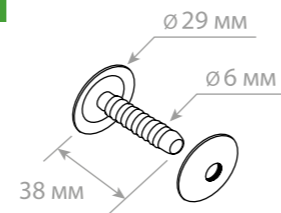

CODE
251066-01

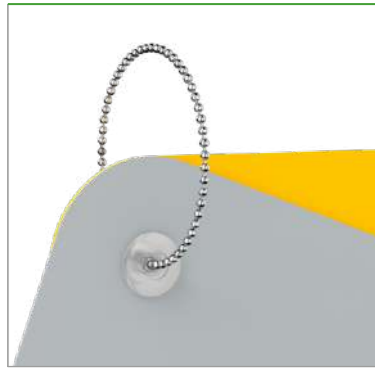

**HOLE SNAP-3** Rivet fastener with hole

This fastener fits 5-6mm holes. Connects materials with total thickness up to 5 mm. Has a 2 mm wide hole that goes through the fastener.

**Color:** Tr  
**Packaging:** 100 pcs.

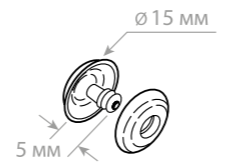

CODE
251050



**QUICK-SNAP** Flexible ribs fastener

A fastener with flexible ribs to securely lock multiple material layers. To ensure even stronger hold has a second part to be fixed from another side. Different lengths and colors available.

**Color:** Wh  
**Packaging:** 100 pcs.

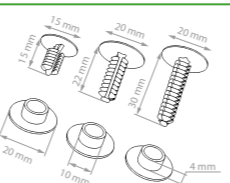

COLOR	LENGTH, MM	CODE
White	15	254356
White	22	254357
White	30	254358
COLOR LOCK MODEL CODE		
White	Snap Lock R	254360
White	Snap Lock F	254359

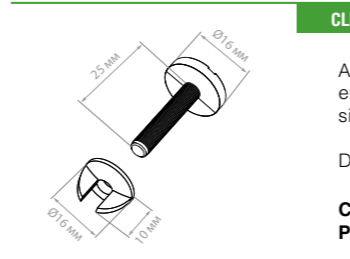

**CLICK-SCREW** Flexible ribs fastener

A fastener with flexible ribs to securely lock multiple material layers. To ensure even stronger hold has a second part to be fixed from another side.

Different lengths and colors available.

**Color:** Tr Sc  
**Packaging:** 100 pcs.

COLOR	CODE
Black	254444
Transparent	254405

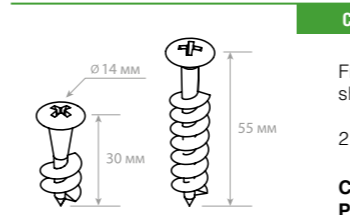

**CB-SCREW** Plastic screw for cardboard displays

Fixed with a usual screddriver this plastic screw can firmly fix cardboard sheets together.

2 lengths available - 30 and 55 mm.

**Color:** Tr  
**Packaging:** 100 pcs.

LENGTH, MM	CODE
30	254265-30
55	254265-55

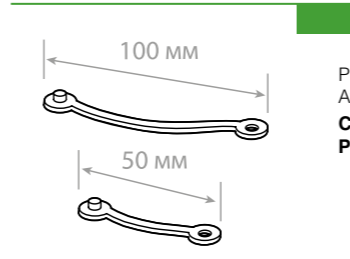

**HM** Plastic clip

Plastic clip with a lock. Used to suspend signs and poster sleeves. Available lengths - 50, 100mm.

**Color:** Tr  
**Packaging:** 100 pcs.

LENGTH, MM	CODE
100	254217
50	254042

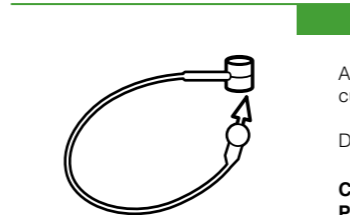

**LS-FIX** Fixed style nylon tie

A fast and easy way to fix plastic pouches, tags and small signs. Must be cut to be removed.

Different lengths available.

**Color:** Tr  
**Packaging:** 500 pcs.

LENGTH, MM	CODE
130	251030
210	251031

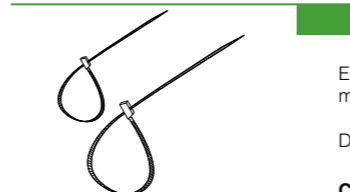

**LS-FLEX** Locking strap

Easy to use nylon strap to fix signs and display parts. Adjusted with ratchet mechanism and locked permanently.

Different lengths and colors available.

**Color:** Wh Sc  
**Packaging:** 100 pcs.

COLOR	LENGTH, MM	CODE
White	100	251006
White	200	251007
White	300	251008
Black	100	251277
Black	200	251278
Black	300	251279





## SUCTION CUPS

Suction cup is a good solution for fixing signs and price tags to glass and other smooth surfaces. We offer a wide range of suction cups with different sizes and functionality.



### SC Universal suction cup

Suction cup Ø 15, 20, 30, 40 is used to fix frames, signs and advertising constructions to glass and other smooth surfaces.

The standard design suction cup, available in different sizes - ranging from 15 to 40 mm. We recommend to check the samples to choose the right size for you task.

Pin Ø – 12 mm.  
Neck Ø – 8 mm.

**Color:** Tr  
**Packaging:** 100 pcs.

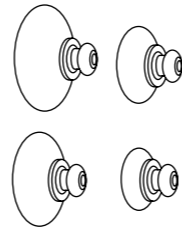

Ø, MM	CODE
15	252145
20	252146
30	252018
40	252078



### SC30-MH Suction cup with a metal hook

Suction cup with metal hook is used for lightweight signs and products.

Ø – 30, 40 mm.

**Color:** Tr  
**Packaging:** 100 pcs.

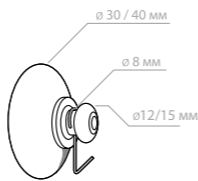

Ø, MM	CODE
30	251212
40	251290

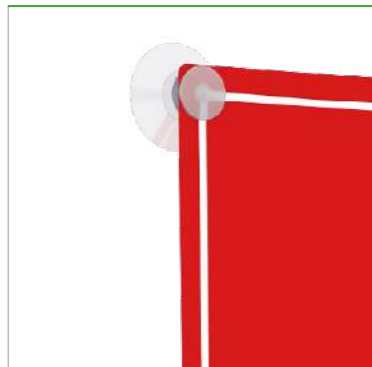

### SC-30PI Suction cup with a pin

Suctions cup with a pin are used to fix the signs with small holes. For signs up to 3 mm thick.

Suction cup Ø – 30 mm.  
Pin Ø – 15 mm.

**Color:** Tr  
**Packaging:** 100 pcs.

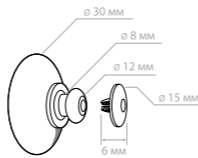

CODE
252042



### SC-46DH Double hole suction cup

Large size suction cup with reinforcing rings and 2 holes from one side to fix other display accessories.

Suction cup Ø – 46 mm  
Holes Ø – 6 mm

**Color:** Tr  
**Packaging:** 100 pcs.

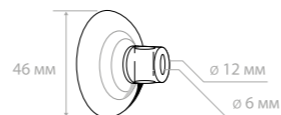

CODE
251053

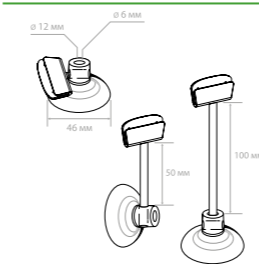

### SC-CLIP Suction cup with sign holder

Large size suction cup with reinforcing rings and price tag holder that can be fixed in 2 different positions.

Different rod lengths available.  
Suction cup Ø – 46 mm  
Holes Ø – 6 mm

**Color:** Tr  
**Packaging:** 100 pcs.

LEG HEIGHT, MM	CODE
0	252761
50	252762
100	252763

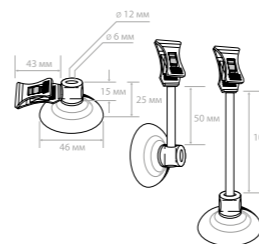

### SC-CLAMP Suction cup with clip

Large size suction cup with reinforcing rings and plastic clip that can be fixed in 2 different positions and can hold inserts up to 2mm thick.

Different rod lengths available.  
Suction cup Ø – 46 mm  
Holes Ø – 6 mm

**Color:** Tr  
**Packaging:** 100 pcs.

LEG HEIGHT, MM	CODE
0	202221
50	252070
100	252071



## SUSPENSION ACCESSORIES

We have a wide choice of suspension accessories to fix advertising products on the ceiling. They differ in fixing mode and holding capacity, so we recommend to check the samples to make the right choice.

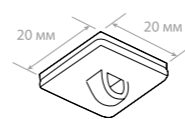

### MB Square adhesive clip for lightweight signs

Injected clip with adhesive tape for signs up to 1kg.

**Color:** Wh  
**Packaging:** 100 pcs.

CODE
254001

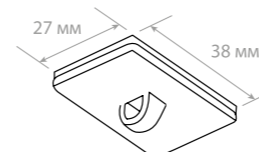

### MB2K Rectangular adhesive clip for middle weight signs

Injected clip with adhesive tape. Bigger base size allows to use this clip with signs up to 2,5 kg.

**Color:** Wh  
**Packaging:** 100 pcs.

CODE
254003





**MBR** Round adhesive clip for lightweight signs

Round injected clip with adhesive tape for signs up to 1kg.

**Color:** Wh   
**Packaging:** 100 pcs.

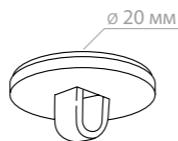

**CODE**  
**254002**



**MBR-RT** Round injected clip for with adhesive transparent tape

Round injected clip for with adhesive transparent tape for fixing of different materials on surfaces of furniture and household appliances.

Base Ø – 20 mm.

**Color:** Tr   
**Packaging:** 100 pcs.

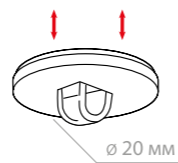

**CODE**  
**251098**

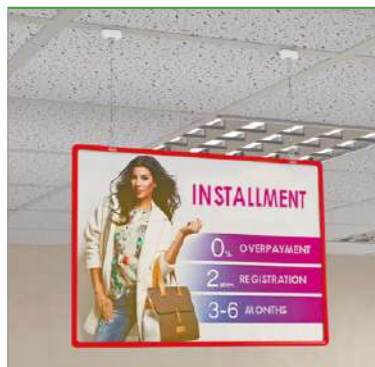

**MAGNET-LOOP-S** Small magnetic ceiling loop

Easily fixed on any metal surface – ceiling grid, tubes, ventilation pipes. The maximum sign weight depends on the metal surface, is around 1,0-1,5 kg.

**Color:** Wh   
**Packaging:** 10 pcs.

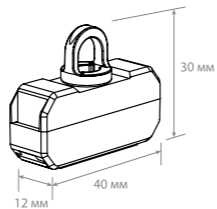

**CODE**  
**251376**



**MAGNET-LOOP** Large magnetic ceiling loop

Easily fixed on any metal surface – ceiling grid, tubes, ventilation pipes. The maximum sign weight depends on the metal surface, is around 1,5-2,5 kg.

**Color:** Wh   
**Packaging:** 10 pcs.

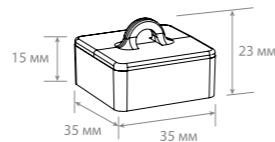

**CODE**  
**251329**



**J-HOOK** «J» hook with adhesive base

This can be fixed on ceiling grip or other clean, flat surface. Hook opening makes it easy to put and remove signs.

Base size – 25x25 mm  
 Maximum load – 0,5 kg

**Color:** Wh   
**Packaging:** 100 pcs.

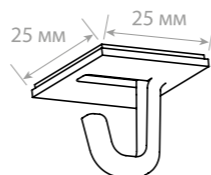

**CODE**  
**254008**

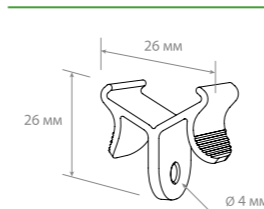

**CEILING CLAMP** Press on ceiling clamp

Easily fixed on the ceiling grip this clip holds up to 1,5kg load. The press on design allows to change position fast and with little effort.

**Color:** Tr   
**Packaging:** 100 pcs.

**CODE**  
**173005**

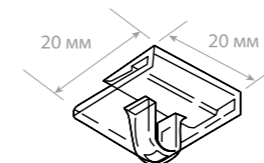

**CEILING CLIP** Clip-on ceiling loop

This clip on loop is fixed on the ceiling grid and can hold signs and decorations up to 1,0 kg.

**Color:** Tr   
**Packaging:** 100 pcs.

**CODE**  
**251078**

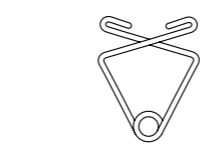

**CRAB CLIP** Metal wire clip

Metal wire clip for signs up to 2 kg.

**Color:** SI   
**Packaging:** 100 pcs.

**CODE**  
**251080**

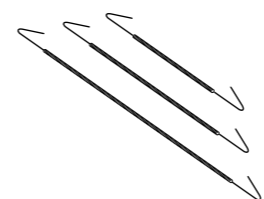

**SPRING** Metal extendable sign holder

A great tool for easy signs and decorations suspension. 3 options for different suspension lengths and sign weight (0,4 kg, 1,0 kg, 1,2 kg). Can be extended only once.

**Color:** SI   
**Packaging:** 100, 50, 25 pcs.

LENGTH / STRETCH, MM	CODE
170/1200	254004
200/1500	254006
250/2500	254005

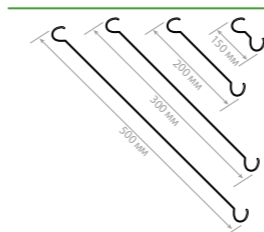

**DS-HOOK** Fixed length metal hook

Easy to use to suspend the signs and posters. Made from 2 mm steel wire it can hold larger signs.

Different lengths available.

**Color:** SI   
**Packaging:** 100, 50 pcs.

LENGTH, MM	CODE
150	254305
200	254282
300	254092
500	254035





**STRIPE-HOOK** Hook for clip strips

Steel wire S-hook of special form is used to hang clip strips on advertising constructions and shelves.

The height: 33 mm.

**Color:** /SI  
**Packaging:** 100 pcs.

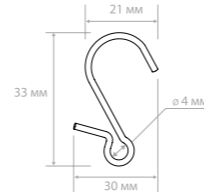

CODE
254174



**S-HOOK** Metal s-shaped hook

Metal S-shaped hooks are used for fixing of different parts of signs to each other.

Thickness of metal wire: 2 mm.

**Color:** /SI  
**Packaging:** 100 pcs.

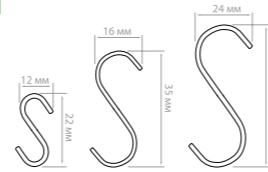

LENGTH, MM	CODE
22	254166
35	254090
52	254095



**C-HOOK** Metal C-shaped hook

Metal C-shaped hooks are used for fixing of different parts of signs to each other.

Thickness of metal wire: 2 mm.

**Color:** /SI  
**Packaging:** 100 pcs.

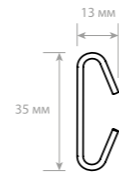

CODE
254029



**CLASP** Pear shaped metal clip

This strong metal clasp can be used to hang signs on tubes and wires. Can be open and securely shut.

**Color:** /SI  
**Packaging:** 100 pcs.

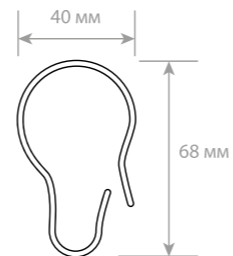

CODE
252005



**M-RING** Hinged metal ring

Hinged metal ring is used in stores to fix posters and signs. Also widely used to create flat products sample kits.

Hinged design snaps easily and locks securely. Available in different sizes.

**Color:** /SI  
**Packaging:** 100 pcs.

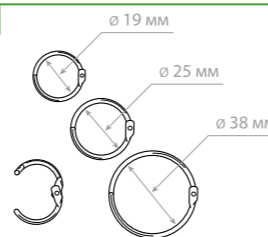

Ø, MM	CODE
19	251048
25	251049
38	251222

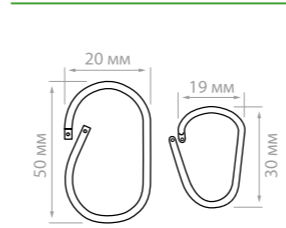

**P-RING** Oval plastic rings

Economical multi-use plastic rings are used to suspend signs and posters.

2 size options available.

**Color:** /Wh  
**Packaging:** 100 pcs.

LENGTH, MM	CODE
19x30	254013
20x50	254128

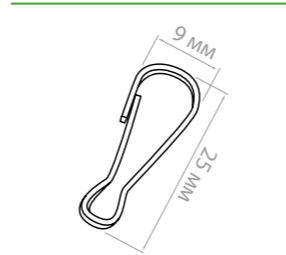

**GREEK CLASP** Small metal clasp

To be used for fixing advertising signs to wire or chain. Can be unlocked by pressing on side part of the clasp with a finger.

Length: 25 mm.  
Thickness: 2,2 mm.

**Color:** /SI  
**Packaging:** 100 pcs.

CODE
252069

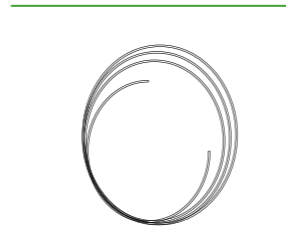

**WIRE** Steel wire

1 mm steel wire for suspension of aluminum profiles  
Packaging: 50 m, 10 m roll.

**Color:** /SI  
**Packaging:** 50 m, 10 m roll.

CODE
251005-xx



**WIRE-CLIP** Tightening wire clip

Aluminum clips to fix the steel wire up to 1 mm thick. To be tighten with pliers.

**Color:** /SI  
**Packaging:** 100 pcs.

CODE
251003

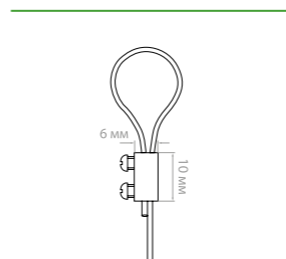

**WIRE FIT** Screw fit for wire

Screw fit allows to fix wire in a loop. 2 screws ensure a secure fixing. For multiple use.

**Color:** /Gl  
**Packaging:** 100 pcs.

CODE
251229





**FLEXIFIXER** Adjustable wire grip

The FLEXIFIXER grip helps to change the wire length in seconds – you simply need to press the button on the grip and pull the wire on the required length. FLEXIFIXER is used in combination with the UNILoop – M or UNI-JOIN suspension hooks (the thread on the grip fits the thread on the hooks).

**Color:** **Packaging:** 1 pc.

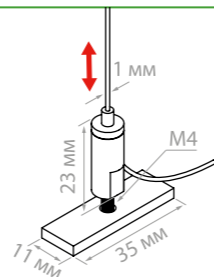

**CODE**  
251168



**CHAIN** Metal chain

Metal chain for sign suspensions to hang signs and banners. It is designed to be durable and weather-resistant. The chain is connected to a hook (C-HOOK, S-HOOK) or a loop at one end and a sign or banner at the other end. The length of the chain can be adjusted to suit the specific needs of the sign or banner being hung, and the metal construction provides the strength necessary to support the weight of the sign.

**Color:** **Packaging:** 30 m roll.

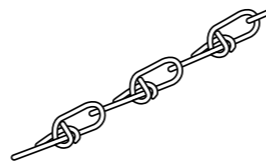

**CODE**  
251004-30



**BALL CHAIN** Metal ball chain

Ball chain allows to adjust the length easily and to be fixed with BC-CONNECTOR. Ball chain is widely used to suspend any advertising constructions and to fix in sets samples of plastics, fabrics and other materials.

Ball Ø: 2,4 mm, 3,2 mm.

**Color:** **Packaging:** 50 m roll.



CODE	BALL DIAMETER (MM)
251303	2,4
251306	3,2

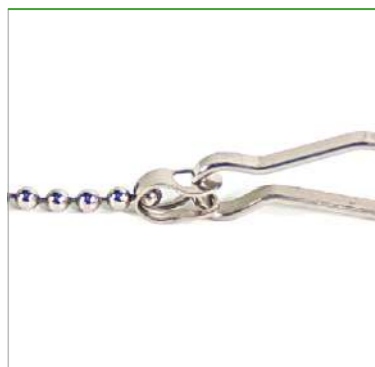

**BC-CLIP** Adapting loop

Loop to adapt the ball chain to the small clasp. Diameter of the loop can be adjust to the ball chain diameter

Hole diameter: 2,4 mm.

**Color:** **Packaging:** 100 pcs.



**CODE**  
251140



**BC-CONNECTOR** Ball chain connector with a lock

An easy to use connector.

Diameter of the balls: Ø 2 mm

**Color:** **Packaging:** 100 pcs.

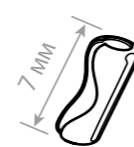

**CODE**  
251189

**DISPLAY HOOKS**

Plastic hooks are widely used in corrugated, plastic and metal displays. Being a cheaper alternative to metal hooks, they are also lighter and, if necessary, can be produced in different colors.

**HOOK TYPES:**

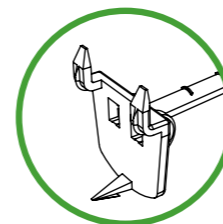

**HOOKS FOR CORRUGATED WALLS**

Widely used in cardboard displays, these hooks have a 3-spike backplate. There is no need to make holes in the corrugated wall to fix these hooks, the spikes are sharp enough to punch through the cardboard.

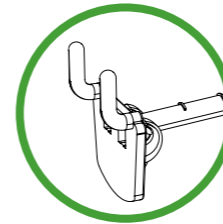

**PEGBOARD HOOKS**

A good alternative to standard metal hooks. Fits most of the 25 mm pegboards and many slatwalls. Different lengths and hook types (single, double ) available.

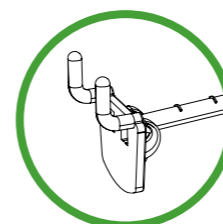

**PEGBOARD HOOKS FOR THICK WALLS**

A good alternative to standard metal hooks for thicker backwalls. Fits walls with 25 mm distance between holes. Different lengths and hook types (single, double) available.

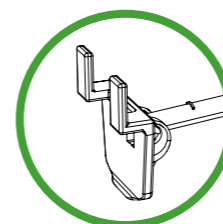

**SLATWALL HOOKS**

Fit most slatwalls on the market. Recommended to use with not heavy products. Different lengths and hook types available.

### HOOKS FOR CORRUGATED WALLS

Fixed in the back wall with special harpoon-type spikes these hooks are usually used with cardboard displays. They are strong enough to hold most of the display items. Standard lengths: 100, 150, 200, 250 mm.



**SINGLE HOOK-CR** Single hook for corrugated backwalls

Fits most of the display products, you only need to choose the right hook length. The ribs on the upper part of the hook secure the product from slipping away.

**Color:** Wh   
**Packaging:** 100 pcs.

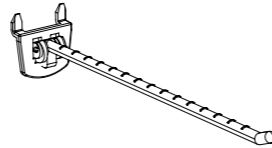

LENGTH, MM	CODE
100	254047
150	254015
200	254145
250	254234



**SINGLE HOOK-PH-CR** Single hook with T-bar for label holder

This single hook has a T-bar for flip style label holder (supplied separately). This ensures that product price is displayed right next to product. Different lengths available.

**Color:** Wh   
**Packaging:** 100 pcs.

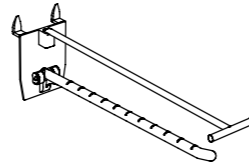

LENGTH, MM	CODE
150	254410
200	254411
250	254412



**DOUBLE HOOK-CR** Double hook for corrugated backwalls

Double hook for cardboard displays. Fits most of the display products, you only need to choose the right hook length. The ribs on the upper part of the hook secure the product from slipping away. Can be used with PP-TAG price holder (supplied separately).

Different lengths available.

**Color:** Wh   
**Packaging:** 100 pcs.

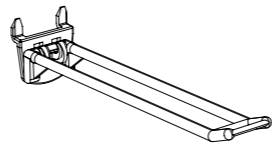

LENGTH, MM	CODE
100	254150
150	254072
200	254229
250	254235



**DOUBLE HOOK-PH-CR** Double hook with T-bar for label holder

This double hook has a T-bar for flip style label holder (supplied separately). This ensures that product price is displayed right next to product.

Different lengths available.

**Color:** Wh   
**Packaging:** 100 pcs.

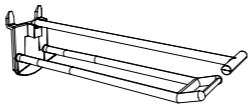

LENGTH, MM	CODE
100	254373
150	254394
200	254374
250	254537

### PEGBOARD HOOKS ( FOR WALLS 1-2MM THICK)

Pegboards (perforated wall) are very common in standard and customized shop equipment. For many situations plastic hooks is a better alternative to traditional metal hooks.

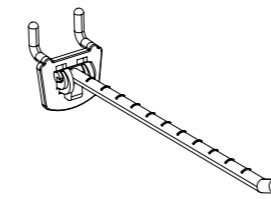

**SINGLE HOOK-MP** Single pegboard hook for 1-2mm thick walls

This hook type fits most of the standard 25 mm step pegboards. The ribs on the upper part of the hook secure the product from slipping away. Different lengths available.

**Color:** Wh   
**Packaging:** 100 pcs.

LENGTH, MM	CODE
100	254178
150	254179
200	254180
250	254233

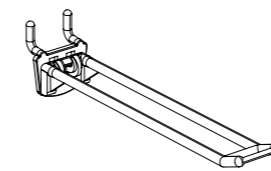

**DOUBLE HOOK-MP** Double pegboard hook for 1-2mm thick walls

This double hook type fits most of the standard 25 mm step pegboards. The ribs on the upper part of the hook secure the product from slipping away. Different lengths available.

Different lengths available.  
**Color:** Wh   
**Packaging:** 100 pcs.

LENGTH, MM	CODE
100	254175
150	254176
200	254177
250	254232



### PEGBOARD HOOKS FOR WALLS 4-6MM THICK

Similar to the hooks of the previous group, these hooks are fixed in the pegboards, but thanks to the backplate design they hold well on thicker materials (4-6 mm thick).

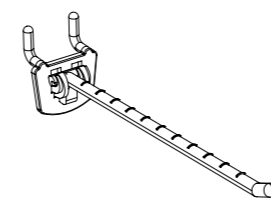

**SINGLE HOOK-MP5** Thick pegboard single hook

This hook type fits most of the standard 25 mm step pegboards with thick walls. The ribs on the upper part of the hook secure the product from slipping away.

Different lengths available.

**Color:** Wh   
**Packaging:** 100 pcs.

LENGTH, MM	CODE
100	254260
150	254261
200	254262
250	254263





**DOUBLE HOOK-MP5** Thick pegboard double hook

This double hook type fits most of the standard 25 mm step pegboards with thick walls. The ribs on the upper part of the hook secure the product from slipping away.

Different lengths available.

**Color:** Wh   
**Packaging:** 100 pcs.

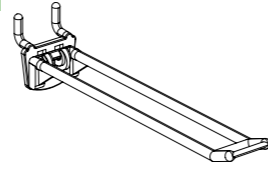

LENGTH, MM	CODE
100	254256
150	254257
200	254258
250	254259

**SLATWALL HOOKS**

Slatwalls and slatwall hooks are commonly used in non-food stores. Plastic hooks is often a good alternative to traditional metal hooks and can be considered as a proper substitute for the purpose.



**SINGLE HOOK-EP** Single plastic hook for slatwalls

This single hook fits most of the slatwall models on the market. The ribs on the upper part of the hook secure the product from slipping away.

Different lengths available.

**Color:** Wh   
**Packaging:** 100 pcs.

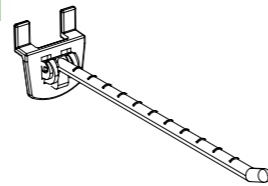

LENGTH, MM	CODE
100	254219
150	254220
200	254221
250	254236



**DOUBLE HOOK-EP** Double plastic hook for slatwalls

This double hook fits most of the slatwall models on the market. The ribs on the upper part of the hook secure the product from slipping away.

Different lengths available.

**Color:** Wh   
**Packaging:** 100 pcs.

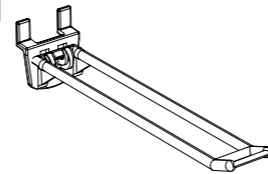

LENGTH, MM	CODE
100	254222
150	254223
200	254224
250	254237



**DOUBLE HOOK-PH-EP** Double slatwall hook with T-bar for price holder

This double slatwall hook has a T-bar for flip up price holders (sold separately). This ensures that product price is displayed right next to product.

Different hook lengths available.

**Color:** Wh   
**Packaging:** 100 pcs.

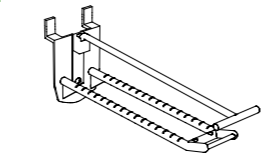

LENGTH, MM	CODE
100	254375
200	254376

**DISPLAY CONSTRUCTION ACCESSORIES**

In this part of the catalogue we some of the most widely used display components. These are the stock items that you can always rely on.

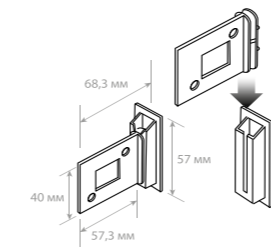

**CORR-A-CLIP** Cardboard holder shelves

Makes it easy to mount and dismount the cardboard display shelves. Clip design provides simple and fast positioning the shelf during assembly.

**Color:** Wh Sc   
**Packaging:** 100 pcs.

COLOR	CODE
White	254148-01
Black	254148-10

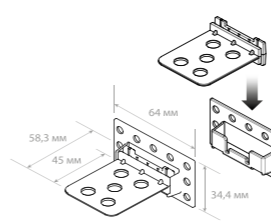

**CORR-H-CLIP** Horizontal shelf support for cardboard displays

2-part horizontal shelf support for corrugated displays. One part is fixed inside the display walls, the other – on the shelf edge.

**Color:** Wh Sc   
**Packaging:** 100 pcs.

COLOR	CODE
White	254298-01
Black	254298-10

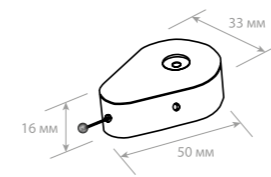

**COILDROP** Sample retractor

This spring retractor is widely used to fix product samples on displays. The retractor can be fixed with a screw through a hole or with adhesive tape. The steel wire has thin plastic coating.

Dimensions: 50x33x16 mm  
 Wire length: 960 mm  
 Wire thickness: 0,8 mm

**Color:** Sc   
**Packaging:** 1 pcs.

CODE
400100

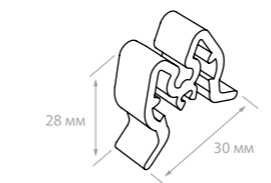

**STOCK LIMITER** Cardboard display shelf support

2-component support for cardboard display shelves. Special holder design ensures fast assembly.

Standard colors: white, black.

**Color:** Wh   
**Packaging:** 100 pcs.

CODE
254187-01



# 7 SHEFTALKERS AND SIGN HOLDERS

- 138 Magnetic sign holders
- 140 Metal clamp sign holders
- 141 Topper sign holders
- 142 Shelftalker holders



## MAGNETIC SIGN HOLDERS

Sign holders with magnets provide ease of use and flexibility for merchandising routine. Fast and easy to mount, they work really well on all types of metal shelves. We offer a wide range of magnetic sign holders, each of them has peculiar features that will help you to solve your specific task.



**MAG-FLEX-TUBE-I** Magnetic sign holder

This sign holder can be fixed on the lower and the upper side of the shelf. Thanks to strong magnets it can hold signs and flags and plastic frames with sign inserts.

Standard tube length - 300mm.  
Standard holder is equipped with 2 plastic hooks.

**Base color:** Wh  
**Tube color:** Sl  
**Hooks color:** Tr  
**Packaging:** 10 pcs.

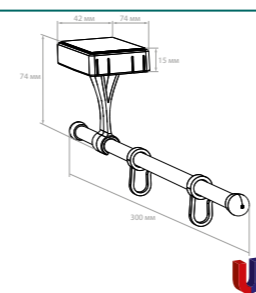

CODE  
252162



**MAG-SW-TUBE-L** Magnetic sign holder with angle adjustment

One of the most common magnetic holders on the market, this product has the angle changing feature. This helps to position signs horizontally even if the holder is fixed on the inclined shelf.

**Base color:** Wh  
**Tube color:** Sl  
**Hooks color:** Tr  
**Packaging:** 10 pcs.

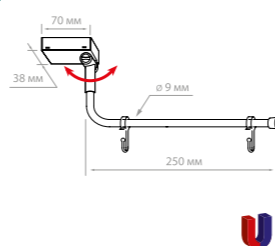

CODE  
251034



**MAG-SW-TUBE-I** Magnetic sign holder with straight tube

This holder is similar to MAG-SW-TUBE-L, the only difference is the straight tube. This feature makes it useful for fixing the holder on vertical metal surfaces.

**Base color:** Wh  
**Tube color:** Sl  
**Hooks color:** Tr  
**Packaging:** 10 pcs.

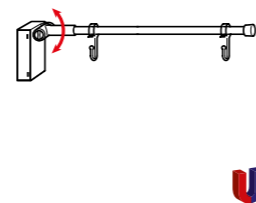

CODE  
251035



**MGT-SW** Swivel magnetic frame holder

Swivel magnetic holder for using plastic frames as shopper stoppers.

Recommended to use with A6 and A5 plastic frames.

**Base color:** Wh  
**Holder color:** Tr  
**Packaging:** 10 pcs.

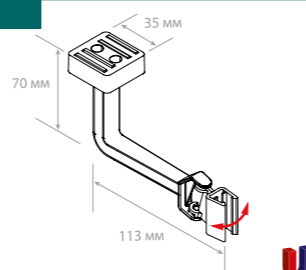

CODE  
102171

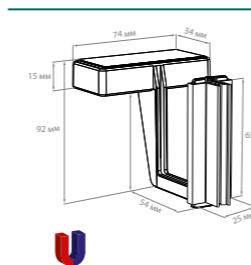

**MAG-GRIP** Magnetic sign holder

This magnetic holder can fix small and medium size signs from 0,5-3,0mm materials. The supergrip allows easy sign fixing and change.

**Color:** Wh Sc  
**Packaging:** 10 pcs

COLOR	CODE
White	252165
Black	252179

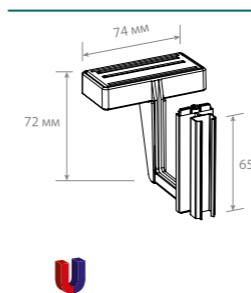

**MAG-FLEX-PF** Magnetic frame holder

This strong magnetic frame holder is fixed from the bottom or top part of the shelf. It is a great tool to attract attention to featured products or segment product in the category.

Recommended to use with A6,A5 or A4 frames.

**Color:** Wh  
**Packaging:** 10 pcs.

CODE  
102580

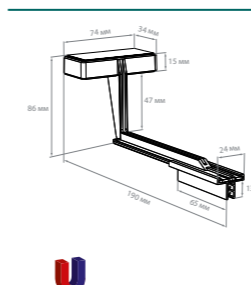
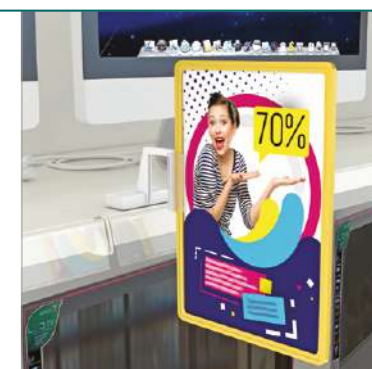

**MGT-SGT-G** Magnetic sign holder

This holder is designed for vertical signs fixed with supergrip from the top side. Recommended to use with carton and plastic signs with thickness in 0,5 to 3,0mm range.

**Color:** Wh  
**Packaging:** 10 pcs.

CODE  
252163

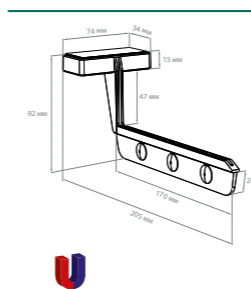

**MGT-SGT-GP** Magnetic sign holder with rivets

This magnetic holder is mounted from the bottom part of the shelf. The sign is to be fixed to the holder with 3 plastic rivets (included).

**Color:** Wh  
**Packaging:** 10 pcs.

CODE  
252164

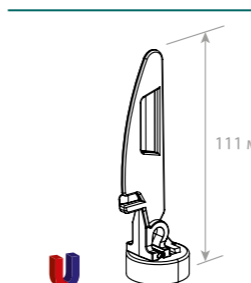

**MAG-PRO-FLAG** Magnetic shelftalker holder

This small magnetic holder is designed to hold small signs and shelftalkers. Fixed on the upper part of shelf it should be placed close to the shelf edge.

Sign insert - 0,3 to 0,7 mm.

**Base color:** Gr  
**Holder color:** Tr  
**Packaging:** 10 pcs.

CODE  
254288



### METAL CLAMP SIGN HOLDERS

Metal clamps are commonly used to fix signs on shelves. They provide reliable grip and high endurance in use.



**FIX-SW** Clamp with movable holder

Powder coated metal clamp with 2 swivel plastic frame holders. The clamp can be fixed on any shelf up to 35mm thick. Recommended to use with A6,A5,A4 frames

Fits shelves up to 32 mm thick.

**Color:** Wh  
**Packaging:** 10 pcs.

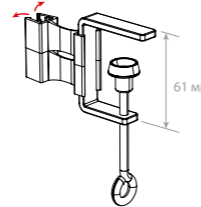

**CODE**  
102059



**CLAMP SGT** Metal clamp with supergrip holder

The supergrip holder on the clamp allows the fix sign with 0.5-3.0 mm thickness.

**Holder color:** Tr  
**Color:** Wh  
**Packaging:** 10 pcs.

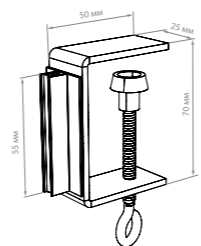

**CODE**  
254204



**CLAMP HOLDER-90** Metal clamp with U-channel

This clamp allows to fix signs up to 6 mm thick. The sign is fixed with 2 inner screws.

**Color:** Wh  
**Packaging:** 10 pcs.

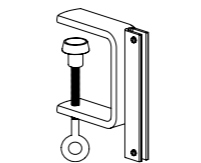

**CODE**  
251021



**CLAMP-TUBE-I-H** Metal clamp sign holder with hooks

The holder consists of a metal clamp and aluminum tube with 2 plastic hooks that can be moved along the tube. Tube length - 250 mm.

**Color:** Wh SI  
**Hooks color:** Tr  
**Packaging:** 10 pcs.

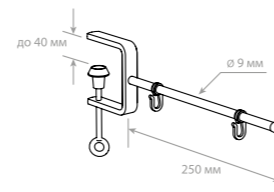

**CODE**  
251022

### TOPPER SIGN HOLDERS

You can use these products to fix topper signs for segmentation and deals communication.

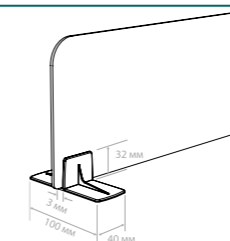

**DIV-FOOT** T-clip for plastic stoppers

This plastic T-clip is the key component of the custom made topper signs or plastic dividers. Recommended to use 2 clips per topper.

Maximum insert thickness - 3,0mm

**Color:** Tr  
**Packaging:** 10 pcs.



TAPE	CODE
-	270074
U	270167

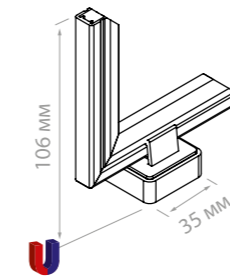

**ALU-BOARD-MGT** Aluminum sign holder with magnets

A set of L-shaped sign holders with magnets. The sign holders are made of aluminum, magnetic holders can be detached when necessary. Depending on the sign thickness it is recommended to use the holder with signs up to 1000mm long.

**Base color:** Wh  
**Base color:** SI  
**Packaging:** 10 pcs.

**CODE**  
254275



### SHELTALKER HOLDERS

Placing sheltalkers next to the featured product is a great tool to advertize the product and drive sales.

It is efficient to use special sheltalker holders in combination with simple flat sheltalkers, the holders are reusable, sheltalkers are cheap to print.



**UNI-CLIP-R** Universal sheltalker holder

This universal sign holder can be fixed on price strips (datatips) 26,30 or 39mm high. The sheltalkers can be made from plastic or carton up to 0,8mm thick. The pin on the surface of the holder helps to hold the inserted sign from falling.

**Color:** Wh

**Packaging:** 100 pcs.

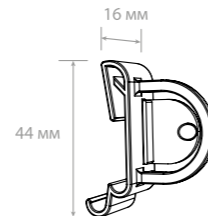

**CODE**

**254097**



**DS-CLIP** Universal sheltalker clip

This clip is designed to fix sheltalkers on price strips. Inserts with thickness 0,6-0,8mm fit this holder, best to use this holder with punched sheltalkers to fit the pin on the holder surface.

**Color:** Tr

**Packaging:** 100 pcs.

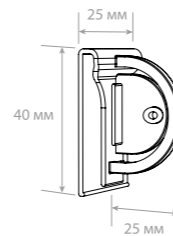

**CODE**

**254094**



**SGKLG** SUPERGRIP sheltalker holder

This holder has 2 grips - 1) to fix the holder on the upper part of price strips 2) to hold (vertically) the sign or sheltalker. Can be fixed on price strips of any size.

Can be used with inserts 0,5-3,0mm thick.

**Color:** Tr

**Packaging:** 100 pcs.

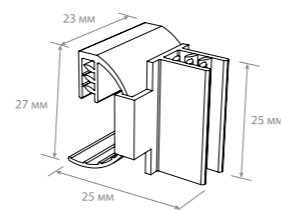

**CODE**

**254022**

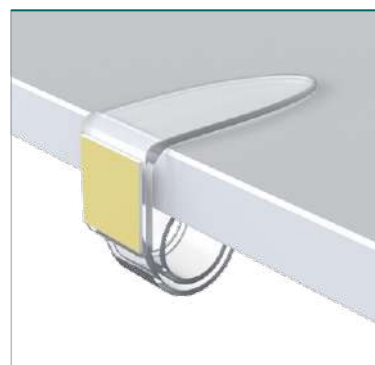

**COIL-T** Plastic coil sheltalker holder

Universal holder with adhesive tape on the front part for fixing signs and sheltalkers.

Fits shelf with thickness in the range 6-40mm

**Color:** Tr

**Packaging:** 10 pcs.

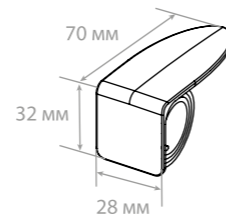

**CODE**

**258001**

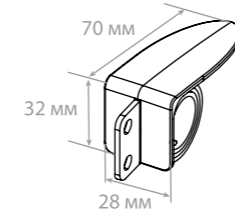

**COIL-L**

Plastic coil clip with vertical holder

Coil clip for vertical signs. The 15x28mm vertical plate with two 5mm holes helps to fix the signs with plastic screws or rivets (see plastic screws and rivets range in "Display accessories" part of the catalogue).

**Color:** Tr

**Packaging:** 10 pcs.



**CODE**

**258003**

### SHELTALKERS: PRO SERIES

Extruded profiles of this series combined with injected sign and flag holders to create professionally looking shelf sets.



**PRO-FLAG**

Stopper holder for PRO30 profile

Injected flag holder to create shelf sets with PRO30 profile. The holders are fixed on the back T-rail of the PRO30 profiles and can hold sheltalker flags from carton or plastic 0,3-0,7mm thick.

**Color:** Tr

**Packaging:** 10 pcs.

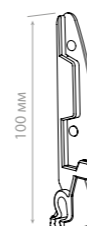

**CODE**

**254203**



**PRO-CLIP**

Clip for PRO30 profile

This injected plastic clip is fixed on the back T-rail of the PRO30 profile to glorify the displayed products. Customized with paper inserts ( 124x40mm ).

**Color:** Tr

**Packaging:** 10 pcs.

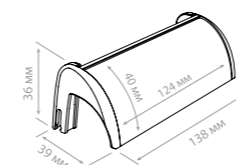

**CODE**

**254202**

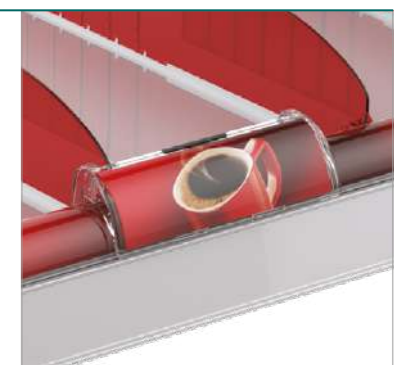

# 8 SUSPENSION SYSTEMS



- 146 ECOTRACK suspension system
- 148 Fruit & Vegetables price cassettes
- 150 Plastic poster profiles
- 152 Aluminum poster profiles
- 154 Chains, wires, suspension accessories

### ECOTRACK SUSPENSION SYSTEM

The core part of the ECOTRACK system is the aluminum ECOTRACK profile. There is a variety of plastic and metal inserts and connectors that help to use it in different retail environments.

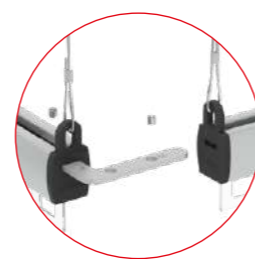
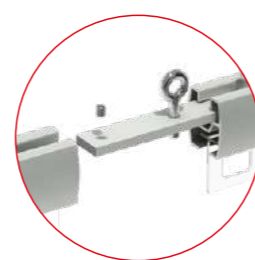

**ECOTRACK** Aluminum profile

Lightweight but rigid aluminum profile. Usually is used in combination with UNI-LINE perforated insert and plastic frames.

Standard length – 2000 mm.

Color: **Sl** **Wh** **Or** **Re** **Gn** **Bl**

Packaging: 1 pcs.

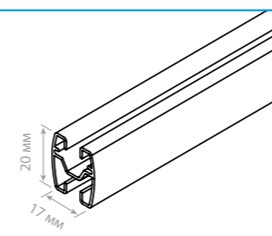

CODE  
282042

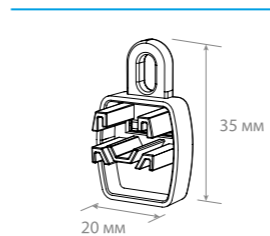

**ECO-CAP** Plastic cap with loop

Plastic cap for ECOTRACK aluminum profile with an integrated loop. The cap and loop combination save time and makes it easy to use.

Color: **Sc**

Packaging: 10 pcs.

CODE  
282043-10

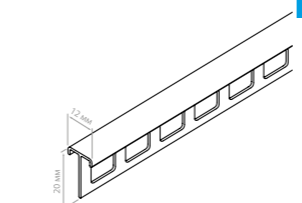

**UNI-LINE** Perforated insert

This T-shaped profile is inserted inside the ECOTRACK profile and makes it easy to hang up signs and posters along the aluminum rail.

Standard length – 1000 mm.

Color: **Tr**

Packaging: 2 pcs.

CODE  
282020-1000



**UNI-LOOP-P** Plastic suspension loop

This plastic loop is fixed into the upper channel of the ECOTRACK profile and can be slid along the profile with a little tension, thus making it easy to change its position.

At least 2 hooks recommended to use per 1 ECOTRACK profile.

Color: **Sc**

Packaging: 10 pcs.

CODE  
282027-10

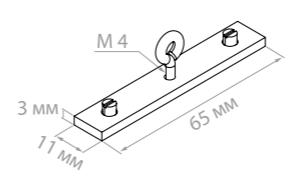

**UNI-JOIN** Metal connector with loop

UNI-JOIN is a metal plate with 2 fixing screws and 1 bigger fixing loop. The plate is slit into the upper channel of the ECOTRACK profile and firmly fixed with the screws and loop in its position. It works best when you need to connect 2 ECOTRACK profiles with each other to make a longer suspension profile.

Color: **Sl**

Packaging: 10 pcs.

CODE  
501498

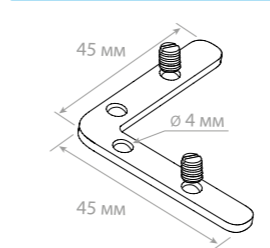
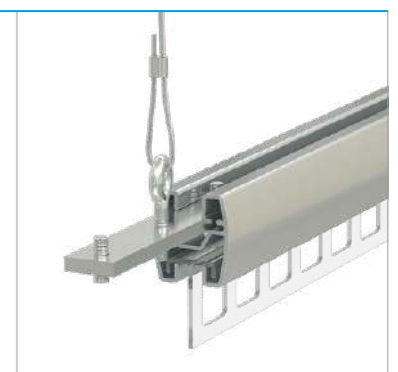

**HT-CONNECTOR-90** Profile 90° connector

This metal connector is used to unite several ECOTRACK profiles into rectangular module. To fix it, you need to push the punched holes in the ECO-CAP and tighten the connector screws.

Color: **Sl**

Packaging: 4 pcs.

CODE  
282051



### PRICE CASSETTES FOR SUSPENSION SYSTEMS

The A4 and A3 price panels are widely used in combination with aluminum suspension profiles in Fruit & Vegetables departments.



PC BOARD-A4

A4 Price cassette

The cassette has 2 sections: the upper part has an A5 plastic sleeve for a paper insert to fix product information, the lower part consists of 5 slots for price «digit books».

**Color:** Sc  
**Packaging:** 1 pc.

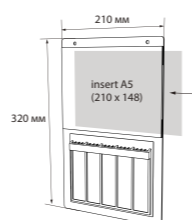

COLOR	CODE
Black	222339



PC BOARD-A3

A3 Price cassette

The cassette has 2 sections: the upper part has an A4 plastic sleeve for a paper insert to fix product information, the lower part consists of 5 slots for price «digit books».

**Color:** Sc  
**Packaging:** 1 pc.

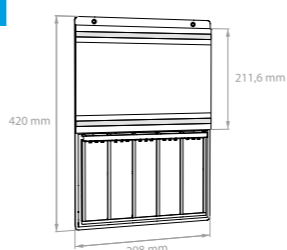

COLOR	CODE
Black	222367

### VISTA PRICE CASSETTE

The VISTA price cassettes is a great tool for price communication in Fruit & Veg departments. They are compatible with all plastic frames accessories and can be made in various colors.

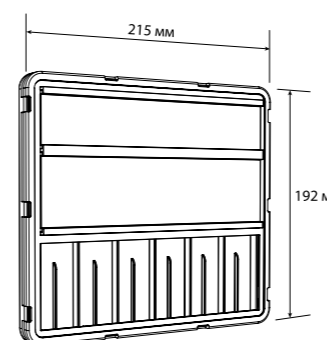

VISTA price cassettes have 2 sliding slots for information inserts and 6 slots for price communication («digit books»). They can be fixed in various positions with plastic frames accessories.

**Color:** Gr Sc Re  
**Packaging:** 10 pcs.

COLOR	CODE
Green	222010-07
Black	222010-10
Red	222010-06

### CLICKER POSTER PROFILE

CLICKER profile is a great tool to fix posters up to 0,7mm thick. The profile is cheap and easy to use.



### GRIPPER POSTER PROFILE

For thicker materials to hang we recommend to use GRIPPER plastic profile. It holds inserts up to 3 mm thick.

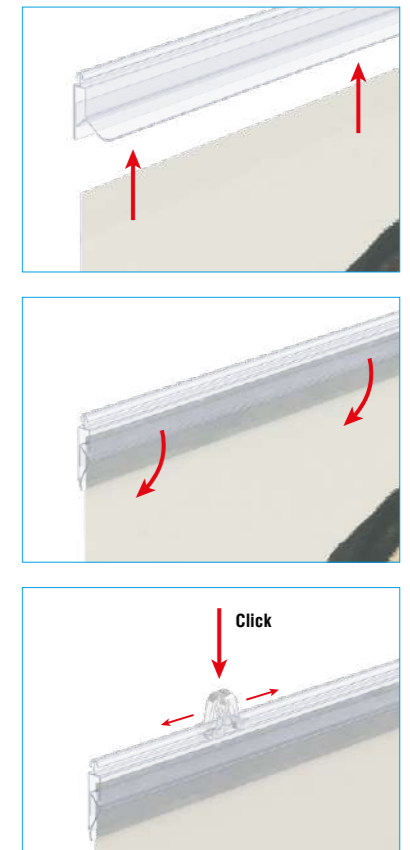

**CLICKER** Plastic locking poster profile

This profile is recommended to use with paper posters up to 1200mm wide. The profile has the «opened» and «locked».

Standard lengths: 600, 1000, 1200 mm.  
Other lengths on request.

Color: **Wh Sc**  
Packaging: 10 pcs.

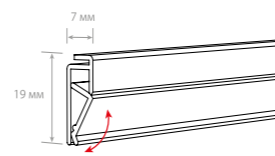

CODE  
252037-xx

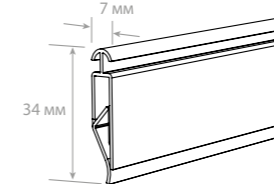

**GRIPPER** Plastic locking poster profile

Depending on the poster weight this profile is recommended to use with paper posters up to 1500mm wide. The profile has the «opened» and «locked» positions.

Standard lengths: 600, 1000, 1200 mm.  
Other lengths on request.

Color: **Tr**  
Packaging: 10 pcs.

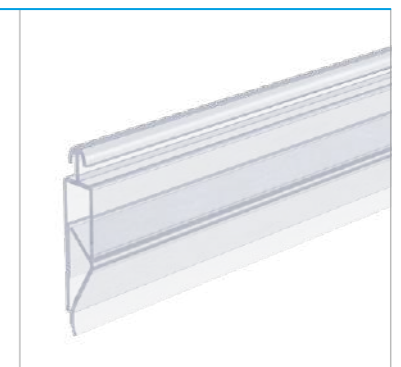

CODE  
254152-xxx



**CLICKER HOOK** Suspension loop for CLICKER profile

This loop is easily attached from the back side of CLICKER poster profile. Recommended to us 2 loops per profile.

Color: **Wh Sc**  
Packaging: 100 pcs.

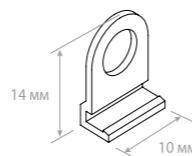

CODE  
252040-xx

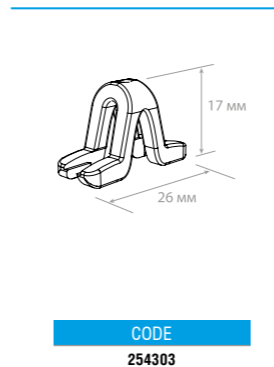

**GRIPPER-CLIP** Suspension loop for GRIPPER profile

This loop is clicked on the upper T-part of the profile and can be slid along to adjust the suspension.

Color: **Tr**  
Packaging: 20 pcs.

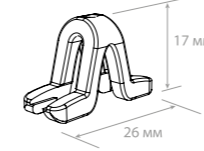

CODE  
254303



### POSTERSNAPPER POSTER PROFILE

Aluminum profile is a perfect tool to get a stable suspension of posters. They are heavier and more sturdy compared to the plastic poster profiles.

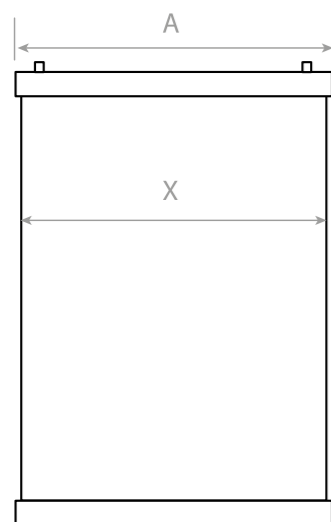

CODE	X	A
254134-0600	600	605
254134-1000	1000	1005
254134-1200	1200	1205

A set of 2 aluminum profiles. One profile is equipped with 2 sliding plastic loops, both profiles have injected plastic caps.

Profile width – 25 mm.  
Standard lengths – 600,1000, 1250 mm.  
Other lengths on request.

**Color:**  **Packaging:** 1 pcs.

### BANNERSNAPPER POSTER PROFILE

BANNERSNAPPER is a heavy and sturdy aluminum profile for vinyl or textile posters. Best solution for getting evenly stretched posters in your store.

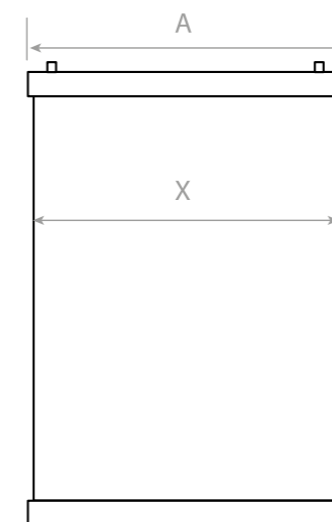
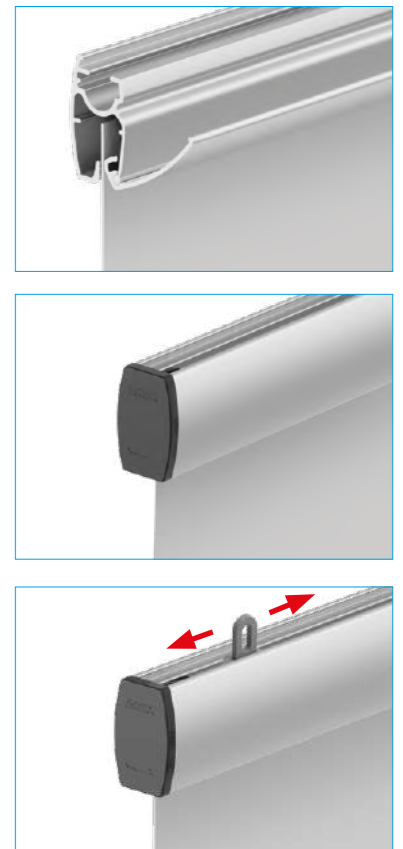

CODE	X	A
282026-0600	600	605
282026-1000	1000	1005
282026-1200	1200	1205

A set of 2 aluminum profiles. One profile is equipped with 2 sliding plastic loops, both profiles have injected plastic caps.

Profile width – 29 mm.  
Standard lengths – 600,1000, 1250 mm.  
Other lengths on request.

**Color:**  **Packaging:** 1 pcs.

### WIRES, CONNECTORS, SUSPENSION ACCESSORIES

You can find a wide range of suspension accessories in our catalogue – wires, chains, hooks and wire clips. They are essential to create simple but reliable suspension systems.



**WIRE**      **Steel wire**

Steel wire is recommended to us for suspension of aluminum profiles. To fix the length you can use WIRE-CLIP or WIRE-FIT clips.

**Color:** SI

**Standard roll:** 50 m, 10 m.



**CODE**

**251005-xx**



**WIRE-CLIP**      **Locking wire clip**

Used to lock the wire loop for suspension, this aluminum clip is very easy to use – just fix it with pliers and it is done.

One use only.

**Color:** SI

**Packaging:** 100 pcs.



**CODE**

**251003**



**WIRE FIT**      **Locking wire clip with screws**

This clip can be used many times. You fix the wire inside the clip with 2 screws (screwdriver needed, not included).

**Color:** GI

**Packaging:** 100 pcs.

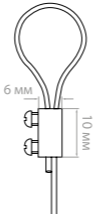

**CODE**

**251229**



**FLEXIFIXER**      **Adjustable wire grip**

FLEXIFIXER is a great tool to adjust the wire length. You need to press the little button to release the wire, adjust the profile position and fix the position by releasing the button.

Designed to use with ECOTRACK profiles, but can be modified to use with other aluminum profiles.

**Color:** SI

**Packaging:** 1 pcs.

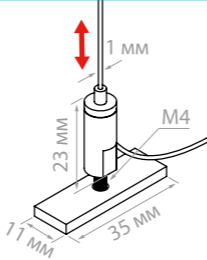

**CODE**

**251168**

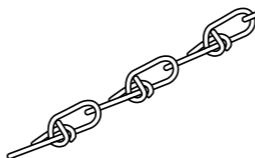

**CHAIN**      **Metal chain**

Metal chain for sign suspensions to hang signs and banners. It is designed to be durable and weather-resistant. The chain is connected to a hook (C-HOOK, S-HOOK) or a loop at one end and a sign or banner at the other end. The length of the chain can be adjusted to suit the specific needs of the sign or banner being hung, and the metal construction provides the strength necessary to support the weight of the sign.

**Color:** SI

**Standard roll:** 30m roll.



**CODE**

**251004-30**



**GREEK CLASP**      **Small metal clasp**

A simple tool to connect signs and display parts to chains and wires.

Length: 25 mm  
Thickness: 2,2 mm

**Color:** SI

**Packaging:** 100 pcs.



**CODE**

**252069**

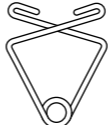

**CRAB CLIP**      **Metal clip for ceiling grid**

Easy to use clip to fix signs and decorations to the ceiling grids. Works like a spring – you need to press it, fix on the grid and then release.

**Color:** SI

**Packaging:** 100 pcs.



**CODE**

**251080**

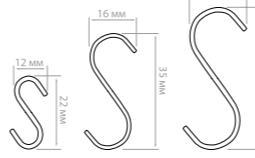

**S-HOOK**      **Metal S-shaped hook**

The S-shaped hooks are universal for signs, posters and frames suspension.

Wire thickness – 2mm.

**Color:** SI

**Packaging:** 100 pcs.



HEIGHT, MM	CODE
22	254166
35	254090
52	254095

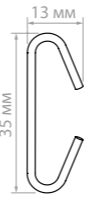

**C-HOOK**      **Metal C-shaped hook**

The C-shaped hook provides a secure and stable suspension and it is very easy to use.

**Color:** SI

**Packaging:** 100 pcs.



**CODE**

**254029**



## 9

# DISPLAYS AND CROSS-MERCHANDISING



- 158 UNIFLEX display
- 159 UNIBOWL displays
- 160 Counter and shelf displays and containers
- 162 Plastic hang strips
- 163 Cashtrays and checkout dividers



**UNIFLEX PLASTIC DISPLAY**

UNIFLEX is a versatile and reliable solution for creating additional points of sale. It is easy to assemble, lightweight but strong, has many options for branding.



**MANY APPLICATIONS**

UNIFLEX has 5 standard shelf sizes - 400x400 mm, 500x400 mm, 600x400 mm, 700x400 mm, 800x400mm and flexible choice of the intershelf distance! You can be creative with this modular system applications - making separate displays and display stacks, promo stands, shop-in-shops and many other!



**EASY ASSEMBLY**

UNIFLEX assembly can be done by one person and takes no more than 5 minutes. No tools required. You can dismantle and assemble it multiple times.



**UNIBOWL DISPLAY**

One of our bestselling displays, this big bowl display consists of just a few parts that you can assemble without any tools. It is a real plug-and-play sales booster!



The display consists of a sturdy and stable plastic base, metal tube and transparent plastic bowl.

If needed, you can fix a pricer or a sign, choosing it from our wide range of sign and pricer holders.

Base color: Wh  
 Bowl color: Tr  
 Packaging: 1 pc.

PRODUCT CODE  
650101

**UNIBOWL-TOWER DISPLAY**

Double bowl UNIBOWL-TOWER display helps to merchandise more products using more products using the same space. You can add dividers inside the bowls to have more separated segments for other products.



The display has 2 bowls - 17 and 24 liters, 2 metal tubes to connect them and a sturdy plastic base.

No tools needed to assemble the display.

If needed, you can fix a pricer or a sign, choosing it from our wide range of sign and pricer holders.

Base color: Wh  
 Bowl color: Tr  
 Packaging: 1 pc.

PRODUCT CODE  
650102

### COUNTER AND SHELF DISPLAYS AND CONTAINERS

Our range includes a variety of plastic injected displays, bowls and containers that you can use for merchandising products in store. Thanks to mass production, they have a very attractive price !



**MINIBOX** Merchandising tray

Compact transparent tray container to display small products. Perfect merchandising tool for pharmacies, droggeries and other shops.

Color:   
 Packaging: 1 pcs.

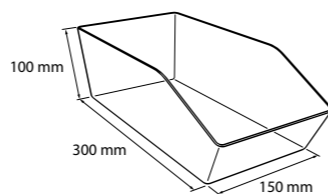

PRODUCT CODE  
**850200**



**MAXIBOX** Merchandising tray

Bigger size transparent container to display any food or non-food products. Recommended for merchandising candies, snacks or dairy products.

Color:   
 Packaging: 5 pcs.

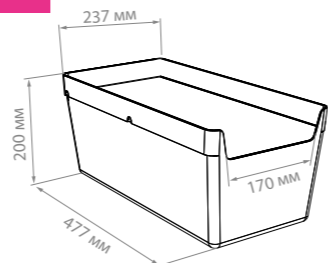

PRODUCT CODE  
**850100**



**CUBE** Cube-shaped merchandising display

This cube-shaped display consists of 2 parts for efficient logistic and storage. It is a great merchandising tool for candies, small cosmetic products or other impulse purchase products.

Color:   
 Packaging: 1 pcs.

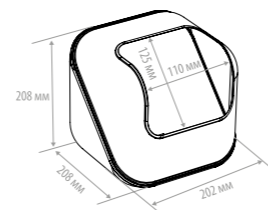

PRODUCT CODE  
**400415**



**BOWL-HOLDER** Metal clamp holder for BOWL

Used together with BOWL to make an on-shelf merchandising display for small products. Metal clamp can be fixed on most metal and wooden shelves.

Color:   
 Packaging: 10 pcs.

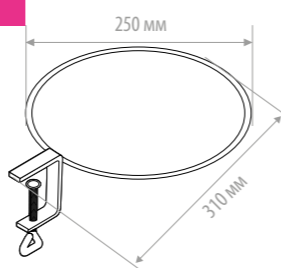

PRODUCT CODE  
**500104**

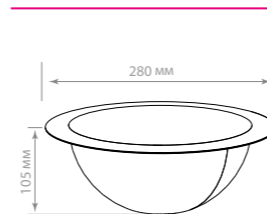

**BOWL** Bowl display with flat bottom

The display is made of transparent plastic for laying out small items. The flat bottom of the display allows to install it on a shelf or use it together with the BOWL-HOLDER clamp.

Color:   
 Packaging: 10 pcs.

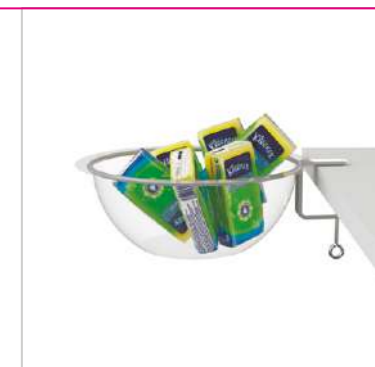

PRODUCT CODE  
**500099**

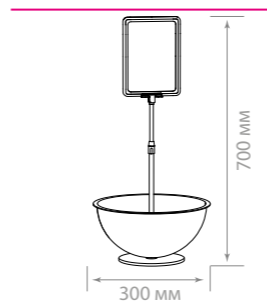

**UNIBOWL-COUNTERTOP** Countertop bowl display

This display consists of a transparent 300 bowl, a round metal base and a plastic tube with pricer holder at the top. It is a great tool to merchandise small products right at the counter.

Color:   
 Packaging: 1 pcs.



PRODUCT CODE  
**730100**

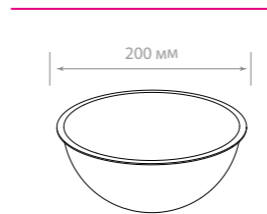

**BOWL-200** Injected transparent bowl

This plastic injected semisphere can be used as a component of displays to merchandise small products.

Standard color - transparent, other colors on request. Diameter - 200mm.

Color:   
 Packaging: 1 pcs.



PRODUCT CODE  
**502700**

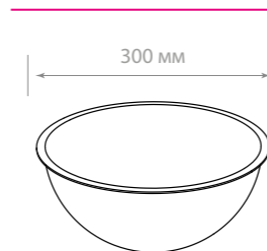

**BOWL-300** Injected transparent bowl

This plastic injected semisphere can be used as a component of displays to merchandise small products.

Standard color - transparent, other colors on request. Diameter - 300mm.

Color:   
 Packaging: 1 pcs.



PRODUCT CODE  
**502778**

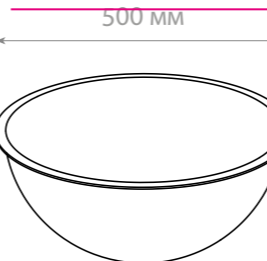

**BOWL-500** Injected transparent bowl

This plastic injected semisphere can be used as a component of displays to merchandise small products.

Standard color - transparent, other colors on request. Diameter - 500mm.

Color:   
 Packaging: 1 pcs.

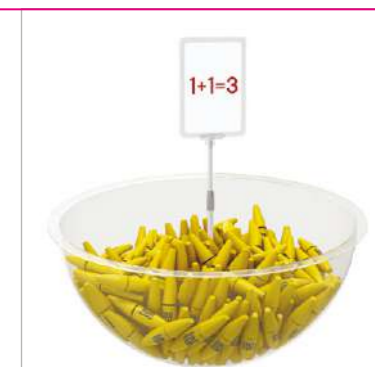

PRODUCT CODE  
**502779**

### PLASTIC HANG STRIPS

Hang strips is a proven tool to boost impulse buys, you can see them in supermarkets, DIY and stationary shops. We present a range of standard hang strips to fit most of the needs in cross merchandising.

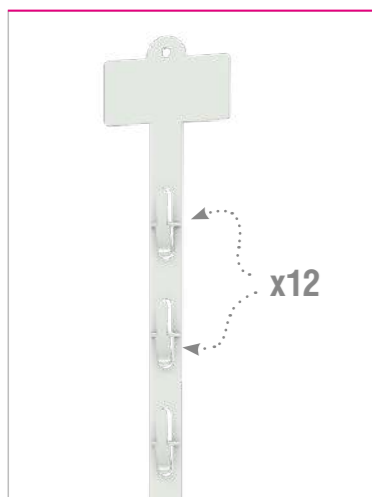

**CLIP STRIP-W** Plastic hang strip

Strong and sturdy injected plastic hang strip. Has 12 strong hooks that can also work as fixing clips.

Distance between hooks - 62mm.  
Strip length - 779mm.

**Color:** Wh  
**Packaging:** 10 pcs.

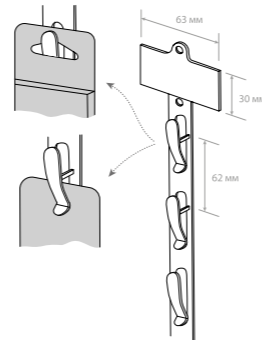

**PRODUCT CODE**  
254064

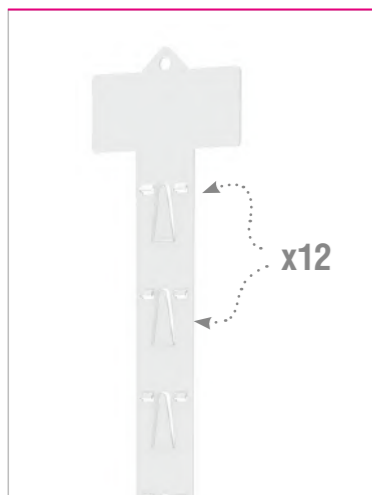

**CLIP STRIP-TR** Plastic hang strip

Semi transparent injected plastic hang strip. Has 12 hooks with locks to fix the hanging products.

Distance between hooks - 48mm.  
Strip length - 623mm.

**Color:** Tr  
**Packaging:** 20 pcs.

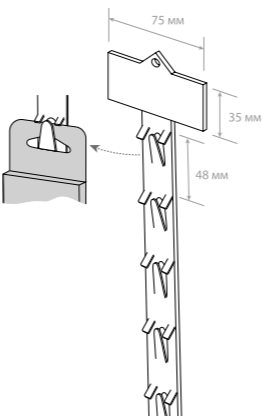

**PRODUCT CODE**  
254065



**STRIPEHOLDER** Plastic hang strip with pockets

This hang strip is supplied flat-packed. When assembled (no tools needed) it can be fixed on supermarket shelves for cross merchandising or secondary placement of small products.

Pocket size: (w\*h\*d) - 130\*175\*55mm

**Color:** Tr  
**Packaging:** 1 pcs.

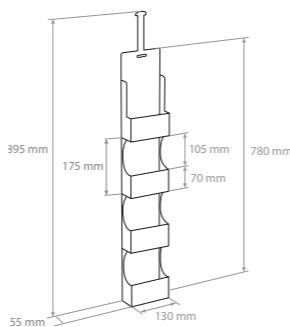

**PRODUCT CODE**  
503028

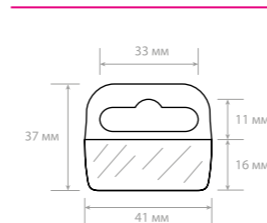

**HANG TAB-4** Self adhesive hang tab

This euro-slot hang tab is used to hang light products (packages or boxes) on merchandising hooks. They have adhesive backing for easy application.

Supplied in 3000 pcs rolls.

**Color:** Tr  
**Packaging:** 3000 pcs roll.

**PRODUCT CODE**  
253004

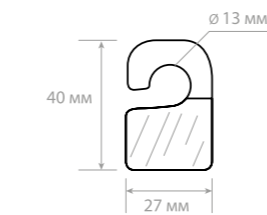

**HANG TAB-5** Self adhesive hang tab

This open hook hang tab is used to hang light products (packages or boxes) on merchandising hooks. They have adhesive backing for easy application.

Supplied in 3000 pcs rolls.

**Color:** Tr  
**Packaging:** 3000 pcs roll.

**PRODUCT CODE**  
253005



### CASHTRAYS AND CHECKOUT DIVIDERS

Combine functionality with advertising effect ! Cashtrays and checkout dividers are needed for the store operations, but they can also carry an advertising message for your customers.

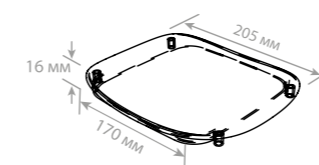

**OPTIMA** Advertising cashtray

2-component plastic cashtray. You can fix a 157x157mm advertising poster inside to promote featured products or services.

Has 4 anti-slip feet.

**Color:** Tr  
**Packaging:** 1 pcs.

**PRODUCT CODE**  
255002-00

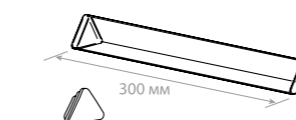

**CHECKOUT DIVIDER** Advertising checkout divider

This universal divider is used at checkouts to separate different customers purchases. It is possible to use as a simple media tool, just put a printed insert inside to advertise anything to your customers.

Standard length - 300mm.  
2 plastic caps are included.

**Color:** Tr  
**Packaging:** 1 pcs.

**PRODUCT CODE**  
255006



**INDEX**

<b>A</b>					
2T-RAIL	25	BASE-XL-CLIP	84	CHOCO-TRAY	7, 12
ACR-HOLDER 150	49, 111	BASIS	30, 50	CHOCO-TRAY-SET11	12
ACR-HOLDER 210	48, 110	BB CHICKEN	101	C-HOOK	128, 130, 155
ACR-PP A4	111	BB CLOUD	101	CLAMP	90
ACR-PP A5	111	BB COFFEE CUP	101	CLAMP + SM-FIX	91
ACR-PP A6	111	BB COW	101	CLAMP HOLDER-90	140
ACR-PRICER	106	BB FISH	101	CLAMP SGT	140
ALU-BOARD-MGT	141	BC-CLIP	130	CLAMP-DBL	91
ALU-DIV	25	BC-CONNECTOR	130	CLAMP-T	33, 42, 91
ALUTUBE	30, 34, 46	B-CLIP	45	CLAMP-T-SW	42, 91
ANT	68	BOWL	161	CLAMP-TUBE-I-H	140
		BOWL-200	161	CLASP	128, 130
		BOWL-300	161	CL-CLIP	84
		BOWL-500	161	CLICKER	150
		BOWL-HOLDER	160	CLICKER HOOK	150
<b>B</b>				CLIP STRIP-TR	162
BACK+BACKLINE	13			CLIP STRIP-W	162
BACK-FR-TM	13	<b>C</b>		CLIP-GRIP	85
BACK-XL / -TM	13	CARDCLAMP-VL	34	COILDROP	135
BALL CHAIN	130	CARDFIX-75	88	COIL-L	143
BANNERSNAPPER	153	CARDFIX-90	88	COIL-T	142
BASE CLIP	83	CB-FIX	49	COLOR	69
BASE-75	33, 41	CB-SCREW	123	CORR-A-CLIP	135
BASE-90	42	CC39	67	CP-CLIP	33, 45
BASE-ML	30, 50	CLICK-SCREW	123	CP-CLIP-SET	33, 45
BASE-MLH	50	CEILING CLAMP	127	CRAB CLIP	127, 155
BASE-ML-ROUND	30, 50	CEILING CLIP	127	CROCS-FIX	47
BASE-XL-ROUND	50	CHAIN	130, 155	CROCS-FIX-T	47
BASE-PL	30, 34, 49	CHECKOUT DIVIDER	163		
BASE-ROD-T	84				

**INDEX**

CUBE	160	DIV120-BT80	5, 6, 9	F-CLIP-SW	43
CUBE-CLIP	89	DIV120-BTW120	9	FIX-SW	31, 42, 140
		DIV200	10	FLEX-BACK	13
<b>D</b>		DIV30-B	6, 8	FLEXIFIXER	130, 154
DBH	65	DIV30-BT35	8	FLU-CLIP-00	45
DBHH	69	DIV60-B	8	FORTA GROSSA-0	15
DBR	64	DIV60-BT30	8	FORTA GROSSA-1	18
DELI-CL	80	DIV-FOOT	11, 141	FORTA GROSSA-2	15
DELI-CLICK	81	DIV-L	4, 12	FORTA GROSSA-3	19
DELI-FOT-SET	78	DIV-LS	12	FORTA GROSSA-4	6, 15, 18
DELI-FOT-ST	80	DIV-L-SLIM	11	FORTA MAGNA-1	19
DELI-FOT-UNBO	80	DIVT-150	7, 10	FORTA NORMA-0	16
DELI-ICE-SET	79	DIVT-150-TM	11	FORTA NORMA-1	16
DELI-MINISTICK-ICE	81	DIVT-80	10	FORTA NORMA-2	15
DELI-SH	80	DIVT-80-TM	10	FORTA QUADRA-0	18
DELI-SIDE-SET40	78	DIVT-T-150	7, 11	FORTA QUADRA-1	18
DELI-SIDE-SET90	78	DIVT-T-150-TM	11	FORTA SLIMA-0	16, 19
DELI-STICK	80	DOUBLE HOOK-EP	134	FORTA SLIMA-1	16, 19
DELI-STICK-ICE	81	DRA	65	FOT-CLIP	84
DELI-TECHNO-SIDE-SET40	79	DS-CLIP	142	FOT-FXS	84
DELI-UNBO 40	81	DS-HOOK	127	FRAME CLAMP	31, 42
DELI-UNBO 90	81			FRAME HOLDERS A3	36
DELI-UNBO-SET40	78	<b>E</b>		FRAME HOLDERS A3 Duo	37
DELI-UNBO-SET90	79	ECO-CAP	147	FR-RISER	25
DHH	64	ECOTRACK	146, 147, 154	FR-SHEET	24
DIV120-B	9			FR-TRACK	24
DIV120-BT120	9	<b>F</b>		FRAME HOLDERS A3	51
		F-CLIP	43		

INDEX

FRAME HOLDERS A3 DUO	51	HOOK-CR	132	LP39	67
FRW39	67	HOOK-EP	134	L-RAIL15	25
FW	116	HOOK-MP	133	L-RAIL30-TF / TM	21
FW-ADT	117	HOOK-MP5	134	L-RAIL80-TF / TM	21
FWG	115	HOOK-PH-CR	132	LRY	67
FX	82	HSAC	66	LS-FIX	123
FX-CLAMP	82	HT- CONNECTOR-90	147	LS-FLEX	123
FX-CLAMP-SLIM	82			LST	66
FX-GRIP	82	<b>I</b>		<b>M</b>	
FXS	83	INFO-CLIP	46	MAG-BASE-XL	51
FXS-DBL	83	INFOFRAME	57, 58, 60	MAG-CLIP	83
FZL-CLIP	27	INFOLINE-ECO	60	MAG-FLEX-PF	41, 139
FZL-DIV	27	INFOLINE-F	61	MAG-FLEX-TUBE-I	138
FZL-PRICER	27	INFOLINE-W	58	MAG-FXS	83
		INFOSTAND-XL	36	MAG-GRIP	139
<b>G</b>		IP	67	MAGNET-00	34, 40
GLS	68			MAGNET-90	34, 40
GREEK CLASP	129, 155	<b>J</b>		MAGNET-LOOP	126
GRIPPER	151	J-HOOK	126	MAGNET-LOOP-S	126
GRIPPER-CLIP	151	JOKER CLIP	45	MAGNET-MINI	40
				MAGNET-ROD	51
<b>H</b>		<b>K</b>		MAG-PRO-FLAG	139
HANG TAB-4	163	KE	65	MAG-STD-BASE	51
HANG TAB-5	163	KOL	65	MAG-SW-TUBE-I	138
H-CLIP-SW	44			MAG-SW-TUBE-L	138
HEL	64	<b>L</b>		MAXIBOX	160
HM	123	LARGE SNAP	122	MB	125
HOLE SNAP-3	122				

INDEX

MB2K	125	PC HOOK	97	PRO-FLAG	143
MBR	126	PC-CLAMP-T	95	PS-M	114
MBR-RT	126	PC-CL-CLIP	97	PS-T	114
MENU HOLDER	108, 109	PC-CLIP	97		
MET-DIV	25	PC-DELI-FOT-SET	96	<b>Q</b>	
MF-CLIP	44	PC-DELI-ICE-SET	96	QUICK LOCK	122
MGT-RND-00	41	PC-DELI-SIDE- SET40	79	QUICK-SNAP	122
MGT-RND-90	41	PC-DELI-STICK- SET	96	<b>R</b>	
MGT-RND-180	41	PC-DELI-UNBO- SET90	79, 96	RING-CLIP	85, 86, 87
MGT-SGT-G	139	PC-GRIP	97	ROLL-CLIP	85
MGT-SGT-GP	139	PC-ROLL-CLIP	97	ROLL-CLIP-L	85
MGT-SW	31, 40, 138	PC-STAND	95		
MIDICLIP	88	PF	30, 31, 32, 33, 34, 36, 37, 59	<b>S</b>	
MINIBOX	160	PF-JOIN	32, 45	SC	124
MINISTICK	89	PH	112, 113	SC30-MH	124
M-RING	128	POSTERFRAME	57	SC-30PI	124
MV-CLIP	89	POSTERLINE WALL	59, 61	SC-46DH	124
		POSTERSNAPPER	152	SC-CLAMP	125
<b>O</b>		PP	30, 31, 32, 33, 34, 39	SC-CLIP	85, 125
OPTIMA	163	P-PRICER	107	SC-FLEX-T	43
		PP-TAG	69	SGJ	120
<b>P</b>		P-RING	129	SGKLG	121, 142
PC BOARD-A3	148	PRISM	88	SGKLG-00	121
PC BOARD-A4	148	PRO30	64	SGT-25	120
PC DELI-SIDE-SET	96	PRO30	21	SGT-40	120
PC DIGIT-A7	94	PRO-CLIP	143	SGT-FLEX	120
PC DIGIT-A7L	94			SGW	121
PC DIGIT-A8	94				

## INDEX

S-HOOK	128, 130, 155	TEL-ALUTUBE-XL	36, 37	UNI-LOOP-P	147
SIG-BOX	17	TEL-LOCK-ALUTUBE	47	UNITRACK	32
SIG-TRAY	17	TEL-PL-TUBE	46	UP-CLIP	32, 43
SIG-TRAY-SET	17	TEL-XL-ALUTUBE	47	UT	66
SM-FIX	49	TEN	66		
SPIRAL-CLIP	89	TF-A4	32, 56	<b>U</b>	
SPRING	127	T-L	48	V-CLAMP	95
ST-HOLDER	34	TM 1/3 A4	35	V-CLAMP-PF	43, 91
STOCK LIMITER	135	TM 1/4 A4	34, 35	VH	68
STRIPEHOLDER	162	TM A7	54	VH39-39	69
STRIPE-HOOK	128	TM A8	35, 54	VIKING SCREW	121
SW-CLIP	48	T-RAIL10	5, 6, 20	VISTA	149
		T-RAIL30-TF /TM	21		
		T-RAIL-TEGO	20	<b>W</b>	
<b>T</b>		T-S	30, 48	WB-CLIP 00	44
TAIL ADAPTER	94	TUBE HOOK	44	WB-CLIP 90	44
TECHNO COIL CLIP	35, 55	T-XL	37, 48	WIRE	129, 154
TECHNO DELI CLIP	55			WIRE FIT	129, 154
TECHNO FX-CLIP	55	<b>U</b>		WIRE-CLIP	129, 154
TECHNO MGT-CLIP	55	UNI RIVET	122		
TECHNO PERFO CLIP	54	UNIBOWL	159		
TECHNO PRICER CLIP	55	UNIBOWL-COUNTERTOP	161		
TECHNO VL	34	UNIBOWL-TOWER	159		
TEL-ALUTUBE	30, 46	UNI-CLIP-R	142		
TEL-ALUTUBE-STH	47	UNIFLEX	158		
		UNI-JOIN	147		
		UNI-LINE	147		